

Jaw Couplings

IN THIS SECTION:

- L Type
- LC Type
- Al Type - Aluminum
- SS Type - Stainless
- RRS and RRSC Types - Spacer
- C and H Type - Medium / Heavy Duty
- RRC Type - Spacer





BY TIMKEN

Warnings



WARNING

Failure to observe the following warnings could cause the power transmission product to break and parts to be thrown with sufficient force to cause serious injury or death.

Selection. Do not exceed catalog ratings. Refer to the Lovejoy catalog for proper selection, sizing, horsepower, torque range, and speed range of these products.

Installation. Proper maintenance, handling, and shop practices are critical. Follow all installation instructions included with the product and provided by your equipment manufacturer, and all applicable federal, state, and local regulations concerning the safe operation and maintenance of manufacturing equipment.

Operation. Avoid sudden shock loads during start up and operation.

Do not operate a coupling assembly with improper alignment or bolt torque or with damaged or worn elastomeric elements. Inspect the assembly for these conditions shortly after initial operation and periodically thereafter.

The coupling assembly should operate quietly and smoothly. If the coupling assembly vibrates or makes a beating sound, shut down the equipment immediately and recheck the alignment.

Disclaimer

This catalog is provided solely to give you analysis tools and data to assist you in your product selection. Product performance is affected by many factors beyond the control of Lovejoy. Therefore, you must validate the suitability and feasibility of all product selections for your applications.

Lovejoy does not manufacture or sell power transmission products for elevators, man lifts, or other devices that carry people. We make no representation or warranty concerning such uses disclaim all liability for harm that might result from the use of our products in those applications.

Lovejoy products are sold subject to Lovejoy terms and conditions of sale (view at www.lovejoy-inc.com/resources), which include our limited warranty and remedy. Please consult with your Lovejoy engineer for more information and assistance.

Every reasonable effort has been made to ensure the accuracy of the information in this writing, but no liability is accepted for errors, omissions or for any other reason.

If you have any questions, contact the Lovejoy Engineering Department at 1-630-852-0500 or email appleng@lovejoy-inc.com.



Table of Contents

	Running Page No.	Section Page No.
Overview	14	JW-4
Elastomers > Overview	15	JW-5
Selection Process.....	16	JW-6
Application Service Factors > Selection Data.....	18	JW-8
Performance Data	19	JW-9
Nomenclature	20	JW-10
L Type Spiders / Hub Spline Bores > Item Selection	21	JW-11
L Type Inch Bore / Keyway > Item Selection.....	22	JW-12
L Type Metric Bore / Keyway > Item Selection.....	23	JW-13
LC Type Inch Bore / Keyway > Item Selection	24	JW-14
LC Type Spiders / Metric Bore / Keyway > Item Selection	25	JW-15
AL and SS Type Inch Bore / Keyway > Item Selection.....	26	JW-16
AL Type Spiders / Metric Bore / Keyway > Item Selection	27	JW-17
RRS and RRSC Type / Inch Bore / Keyway > Item Selection	28	JW-18
RRS Type Spacer / Metric Bore / Keyway > Item Selection	29	JW-19
C Type Cushions / Collar and Inch / Metric Bore / Keyway	30	JW-20
H Type Cushions / Collar and Inch / Metric Bore / Keyway	31	JW-21
RRC Type Spacer / Adapter Hubs.....	32	JW-22
L, AL, LC, C, H, and RRS Type Ratings > Performance Data.....	33	JW-23
Elastomers > Dimensional Data	34	JW-24
L, C and H Type > Dimensional Data.....	35	JW-25
LC and AL Type > Dimensional Data.....	36	JW-26
RRS and RRC Type > Dimensional Data.....	37	JW-27
RRS Type Metric Spacer, L Type Special Lengths > Dimensional Data.....	38	JW-28

Overview

JW

Jaw Type Couplings

The Jaw Type couplings from Lovejoy are offered in the industry's largest variety of stock bore/keyway combinations. These couplings require no lubrication and provide highly reliable service for light, medium, and heavy duty electrical motor and internal combustion power transmission applications.

Features

- Fail-safe – will still perform if elastomer fails
- No metal to metal contact
- Resistant to oil, dirt, sand, moisture and grease
- More than 850,000 combinations of bore sizes
- Most types available from stock in 24 hours

Applications include power transmission to industrial equipment such as pumps, gear boxes, compressors, blowers, mixers, and conveyors. Lovejoy's Jaw Type couplings are available in 24 sizes from a minimum torque rating of 3.5 in-lbs to a maximum torque rating of 170,000 in-lbs and a bore range of .125 inches to 7 inches. Lovejoy's standard bore program covers AGMA, SAE, and DIN bore/keyway and spline bore combinations.

The Lovejoy Jaw Type coupling is available in a variety of metal hub and insert materials. Hubs are offered in sintered metal, aluminum, bronze, steel, stainless steel, and ductile iron.

L Type

- Coupling offers standard shaft-to-shaft connection for general industrial duty applications
- Standard L Type coupling hub materials are either sintered iron (L035-L190) or cast iron (L225-L276)

LC Type

- Uses the standard L Type hubs with a snap wrap and collar
- Suited for applications up to 3,600 RPM

AL Type

- Aluminum hubs offer light weight with low overhung load and low inertia
- Excellent resistance to atmospheric conditions, perfect for corrosive environment applications

SS Type

- The SS Type coupling provides maximum protection against harsh environmental conditions
- Sizes SS075-SS150 available from stock, other sizes available on request

RRS Type

- Center "drop out" section of this coupling provides proper shaft separation, while also allowing easy elastomer installation without disturbing the hubs or requiring the realignment of shafts
- Accommodates American and European industry standard pump/motor shaft separations
- The spacer is made of glass reinforced plastic, cast iron, or aluminum

SW Type

- Standard L Type coupling with a snap wrap elastomer with retaining ring
- Well suited for standard shaft to shaft connection in general industrial purpose applications under 1,750 RPM

C & H Types

- Couplings provide standard shaft-to-shaft connection for medium (C) and Heavy (H) duty range applications
- Standard C coupling hub is made of cast iron, while the H is constructed of ductile iron



L Type

LC Type



AL Type Jaw



SS Type



RRS Type



SW Type



C & H Types

Elastomers

Overview

Elastomers In Compression

Lovejoy offers four types of elastomer designs to allow for additional flexibility in addressing specific application requirements. One piece designs are used in the "L" and "AL" models (referred to as spiders) and multiple part "load cushions" are used in the "C" and "H" model couplings. The load cushions are in sets of 6 to 14 pieces depending on coupling size.

Solid Center Spider

- The solid center design is commonly used design when shafts of the driver and driven equipment can be kept separate by a standard gap

Open Center Spider

- The open center design allows for the shafts of the driver and driven to be positioned within a short distance
- Open center spiders offer shaft positioning flexibility but have a lower RPM capacity (1,750 RPM maximum for NBR, 3,600 maximum for Urethane/Hytrel®)

Cushions

- Used exclusively for the C and H Type couplings
- Load cushions are held in place radially by a steel collar which is attached to one of the hubs

Snap Wrap Flexible Spider

- Design allows for easy removal of the spider without moving the hubs
- Allows for close shaft separation all the way up to the hubs maximum bore
- Maximum RPM is 1,750 RPM with the retaining ring, but if used with the LC Type (with collar) a 3,600 RPM rating of the coupling applies
- Style is available in NBR and Urethane only, and in limited sizes

Note: ■ Complete technical data for the new Jaw In-Shear elastomer is contained in the next section of this catalog, labeled "JIS" on the page tabs.



Spider Materials

SOX (NBR) Rubber

- The standard material that is highly flexible material that is oil resistant
- Resembles natural rubber in resilience and elasticity, and operates effectively in temperature ranges of -40° to 212° F (-40° to 100° C)

Urethane

- Has 1.5 times greater torque capacity than NBR
- Good resistance to oil and chemicals
- Material provides less dampening effect and operates at a temperature range of -30° to 160° F (-34° to 71° C)

Hytrel

- Flexible elastomer designed for high torque and high temperature operations
- Operates in temperatures of -60° to 250° F (-51° to 121° C)

Bronze

- Rigid, porous, oil-impregnated metal insert exclusively for low speed (max 250 RPM) applications requiring high torque capabilities
- Not affected by water, oil, dirt, or extreme temperatures – operates in temperatures of -40° to 450° F (-40° to 232° C)



WARNING

Failure to follow these cautions could create a risk of injury.

You must refer to page JW-2 for Important Safety Instructions and Precautions for the selection and use of these products. Failure to follow the instructions and precautions can result in severe injury or death.

Selection Process

JW

Jaw Type Coupling Selection Process

The selection process for determining the proper jaw coupling size and elastomer requires using the charts shown on the following pages. There are three components to be selected, two hubs and one elastomer. When the shaft size of the driver and driven of the application are of the same diameter, the hubs selected will be the same. When shaft diameters differ, hubs selected will differ accordingly.

Information necessary before a coupling can be selected:

- HP (or KW) and RPM or Torque of driver
- Shaft sizes of driver and driven equipment and corresponding keyways
- Application description
- Environmental conditions (i.e. extreme temperature, corrosive conditions, space limitations)

List of Charts provided for Selection:

- **Chart 1** – Application Service Factors (page JW-8)
- **Chart 2** – Spider Performance Data (page JW-10)
- **Chart 3** – Jaw Nominal Rated Torque (page JW-10)
- Jaw Type Performance Ratings (page JW-23)

Formulas:

$$\text{Nominal Torque} = \text{in-lb} = \frac{(\text{HP} \times 63025)}{\text{RPM}}$$

$$\text{Nm} = \frac{(\text{KW} \times 9550)}{\text{RPM}}$$

$$\text{Design Torque} = \text{Nominal Torque} \times \text{Application Service Factor}$$

Steps In Selecting A Jaw Coupling

Step 1: Determine the Nominal Torque of your application by using the following formula:

$$\text{Nominal Torque} = \text{in-lb} = \frac{(\text{HP} \times 63025)}{\text{RPM}}$$

$$\text{Nm} = \frac{(\text{KW} \times 9550)}{\text{RPM}}$$

Step 2: Using the Application Service Factors Chart 1 (page JW-8) select the service factor which best corresponds to your application.

Step 3: Calculate the Design Torque of your application by multiplying the Nominal Torque calculated in Step 1 by the Application Service Factor determined in Step 2.

$$\text{Design Torque} = \text{Nominal Torque} \times \text{Application Service Factor}$$

Step 4: Using the Spider Performance Data Chart 2 (page JW-10), select the elastomer material which best corresponds to your application.

Step 5: Using the Jaw Nominal Rated Torque Chart 3 (page JW-10), locate the appropriate elastomer material column for the elastomer selected in Step 4.

Scan down this column to the first entry where the Torque Value in the appropriate column is greater than or equal to the Design Torque calculated in Step 3.

Once this value is located, refer to the corresponding coupling size in the first column of the Jaw Nominal Rated Torque Chart 3 (page JW-10).

Refer to the maximum RPM value (page JW-23) for this elastomer torque capability to ensure that the application requirements are met. If the requirement is not satisfied at this point, another type of coupling may be required for the application. Please consult Lovejoy engineering for assistance.

Step 6: Compare the application driver/driven shaft sizes to the maximum bore size available on the coupling selected. If coupling bore size is not large enough for the shaft diameter, select the next largest coupling that will accommodate the driver/driven shaft diameters. Refer to Chart 3 (page JW-10).

Step 7: Using the UPC number selection table (pages JW-12 or JW-13), find the appropriate Bore and Keyway sizes required and locate the Lovejoy UPC number.

Selection Process

Selection Example

A coupling is needed to connect a 20 HP standard electric motor rated at 1,800 RPM to a rotary pump. The shaft size of the electric motor (driver) is 2.0 inches and the pump (driven) is 1.75 inches. There are no special environmental conditions and the general operating temperature is normal room temperature of 72° F. Less than 1° of misalignment is expected.

Step 1: Determine the Nominal Torque:

$$\begin{aligned} \text{Nominal Torque} &= \frac{(\text{HP} \times 63025)}{\text{RPM}} \\ &= \frac{(20 \times 63025)}{1800} \\ &= 700.28 \text{ in-lb} \end{aligned}$$

Step 2: Using the Application Service Factors Chart 1 (page JW-8), select the service factor which best corresponds to your application. The Application Service Factor for an electric motor with standard torque driving a rotary pump is 1.25. The value of 1.25 is found under the application category Pumps, Rotary, column: Electric Motor w/Standard Torque in Chart 1.

Step 3: Calculate the Design Torque of your application:

$$\begin{aligned} \text{Design Torque} &= \text{Nominal Torque} \times \text{Application Service Factor} \\ &= 700.28 \times 1.25 \\ &= 875.35 \text{ in-lb} \end{aligned}$$

Step 4: Using the Spider Performance Data Chart 2 (page JW-10), select the elastomer material which best corresponds to your application. Since there are no special environmental conditions, the operating temperature is 72° F and less than 1° of angular misalignment is required, the NBR elastomer material is selected.

Step 5: Using the Jaw Nominal Rated Torque Chart 3 (page JW-10), the NBR elastomer column is used to determine the proper coupling size. Scanning down the NBR column, the first entry to accommodate the Design Torque value of 875.35 in-lb is the size L150 with a nominal torque rating of 1,240 in-lb. Referring to page JW-21, the maximum RPM of 1,800 on the electric motor of the application does not exceed the 5,000 RPM maximum allowed for the L150 size coupling with an NBR elastomer.

Step 6: Compare the application driver/driven shaft size to the maximum bore available in the coupling selected (page JW-10). The electric motor (driver) of this application has a shaft size of 2.0 inches and the pump (driven) has a shaft size of 1.75 inches. The L150 coupling has a maximum bore less than the driver shaft size. Continuing down the Maximum Bore column, in Chart 3 (page JW-10), the L190 size is found to have a maximum bore size of 2.125 and is able to accommodate the driver/driven shaft sizes. Therefore, the proper coupling size for this application is a Lovejoy L190 with an NBR elastomer.

Step 7: Using the UPC number Selection table, locate the appropriate Lovejoy UPC numbers. The L Type Spider Table (page JW-11), and the L Type hub table (page JW-12), provides easy reference to the Lovejoy UPC numbers.

Locate the L Type Spider Table (page JW-11).

The spider is selected by scanning down the type column and locating the NBR (Solid) entry. Read across to the L190 column and locate the Lovejoy UPC number of 12274. This number should be prefixed with the Lovejoy UPC number of 685144.

Locate the L Type Hub Table (page JW-12).

The first bore size to be located is for the 2 inch shaft on the electric motor. Scan down the Bore/Keyway column to the 2 inch bore entry. Read across to the L190 column to locate the Lovejoy UPC number of 12303. This number should be prefixed with the Lovejoy UPC number of 685144.

The second bore size to be located is for the 1.75 inch shaft on the pump. Scan down the Bore/Keyway column to the 1-3/4 inch bore entry. Read across to the L190 column to locate the Lovejoy UPC number of 12299. This number should be prefixed with the Lovejoy UPC number of 685144.

Application Service Factors
Selection Data

JW

Application Service Factors

Chart 1

	Service Factors				Service Factors				Service Factors		
	Electric Motor w/ Standard Torque	Electric Motor w/ High Torque	Turbines, Air & Hydraulic Motors		Electric Motor w/ Standard Torque	Electric Motor w/ High Torque	Turbines, Air & Hydraulic Motors		Electric Motor w/ Standard Torque	Electric Motor w/ High Torque	Turbines, Air & Hydraulic Motors
Agitators	1.25	1.50	1.00	Disc Feeder	1.25	1.50	1.00	Pressers			
Band Resaw (lumber).....	1.50	2.00	1.25	Dough Mixer	1.50	2.00	1.25	Brick, Briquette Machine.....	2.00	2.50	1.50
Barge Haul Puller	2.00	2.50	1.50	Draw Bench Conveyor				Notching, Paper, Punch			
Barking (lumber).....	2.00	2.50	1.50	& Main Drive	2.00	2.50	1.50	Printing.....	1.50	2.00	1.25
Bar Screen (sewage).....	2.00	2.50	1.50	Dredges				Pug Mill	1.50	2.00	1.25
Batches (textile).....	1.25	1.50	1.00	Cable reef, Pumps.....	1.50	2.00	1.25	Pulp Grinder (paper).....	2.00	2.50	1.50
Beater and Pulper				Cutter head, Jig, &				Pulverizers			
(paper).....	1.50	2.00	1.25	Screen Drives.....	2.00	2.50	1.50	Hammermill—Light Duty,			
Bending Roll (metal).....	1.50	2.00	1.25	Maneuvering & Utility				Roller.....	1.50	2.50	1.25
Bleacher (paper).....	1.25	1.50	1.00	Winch, Stackers.....	1.50	2.00	1.25	Hammermill—Heavy			
Blowers				Dynamometer	1.25	1.50	1.00	Duty Hog.....	2.00	2.50	1.50
Centrifugal, Vane.....	1.25	1.50	1.00	Dryers (rotary).....	1.50	2.00	1.25	Pumps			
Lobe.....	1.50	2.00	1.25	Edger (lumber).....	2.00	2.50	1.50	Centrifugal, Axial.....	1.25	1.50	1.00
Bottling Machinery	1.25	1.50	1.00	Escalators ¹	1.25	1.50	1.00	Gear, Lobe, Vane.....	1.50	2.00	1.25
Brew Kettles (distilling).....	1.25	1.50	1.00	Extruders (metal).....	2.00	2.50	1.50	Reciprocating—Sgl. or			
Bucket Elevator or				Fans				Dbl. Acting Cylinder.....	2.00	2.50	2.00
Conveyor	1.50	2.00	1.25	Centrifugal.....	1.25	1.50	1.00	Reel, Rewinder (paper)			
Calenders				Cooling Towers.....	2.00	2.50	1.50	Cable.....	1.50	2.00	1.25
Calender (paper).....	1.50	2.00	1.25	Forced Draft, Large				Rod Mill	2.00	2.50	1.50
Calender (rubber),				Industrial.....	1.50	2.00	1.25	Saw Dust Conveyor	1.25	1.50	1.00
Calender-super (paper).....	2.00	2.50	1.50	Feeders				Screens			
Cane Knives (sugar).....	1.50	2.00	1.25	Apron, Belt, Disc.....	1.25	1.50	1.00	Air Washing, Water.....	1.25	1.50	1.00
Card Machine (textile).....	2.00	2.50	1.50	Reciprocating.....	2.00	2.50	1.50	Rotary—Coal or Sand.....	1.50	2.00	1.25
Car Dumpers	2.00	2.50	1.50	Screw.....	1.50	2.00	1.25	Vibrating.....	2.00	2.50	2.00
Car Pullers	1.50	2.00	1.25	Filter, Press-Oil	1.50	2.00	1.25	Screw Conveyor	1.25	1.50	1.00
Cement Kiln	2.00	2.50	1.50	Generators				Slab Conveyor (lumber).....	1.50	2.00	1.25
Centrifugal, Blower,				Uniform Load.....	1.25	1.50	1.00	Slitters (metal).....	1.50	2.00	1.25
Fans, Compressors,				Varying Load, Hoist.....	1.50	2.00	1.25	Soapers (textile).....	1.25	1.50	1.00
or Pumps	1.25	1.50	1.00	Welders.....	2.00	2.50	1.50	Sorting Table (lumber).....	1.50	2.00	1.25
Chemical Feeders				Grit Collector (sewage).....	1.25	1.50	1.00	Spinner (textile).....	1.50	2.00	1.25
(sewage).....	1.25	1.50	1.00	Grizzly	2.00	2.50	1.50	Stoker	1.25	1.50	1.00
Chiller (oil).....	1.50	2.00	1.25	Hammermills				Suction Roll (paper).....	1.50	2.00	1.25
Chipper (paper).....	2.00	2.50	1.50	Light Duty, Intermittent.....	1.50	2.00	1.25	Tenter Frames (textile).....	1.50	2.00	1.25
Circular Resaw				Heavy Duty, Continuous.....	2.00	2.50	1.50	Tire Building			
(lumber).....	1.50	2.00	1.25	Hoists				Machines	2.00	2.50	1.50
Clarifier or Classifier	1.25	1.50	1.00	Heavy Duty.....	2.00	2.50	1.50	Tire & Tube Press			
Clay Working Machinery	1.50	2.00	1.25	Medium Duty.....	1.50	2.00	1.25	Opener	1.25	1.50	1.00
Collectors (sewage).....	1.25	1.50	1.00	Jordan (paper).....	2.00	2.50	1.50	Tumbling Barrels	2.00	2.50	1.50
Compressors				Kiln, Rotary	2.00	2.50	1.50	Washer & Thickener			
Centrifugal, Screw,				Laundry Washer or				(paper).....	1.50	2.00	1.25
Lobe.....	1.25	1.50	1.00	Tumbler	2.00	2.50	1.50	Winches	1.50	2.00	1.25
Reciprocating.....	See Note			Line Shafts	1.25	1.50	1.00	Winders—Paper, Textile,			
Concrete Mixers	1.50	2.00	1.25	Log Hall (lumber).....	2.00	2.50	1.50	Wire	1.50	2.00	1.25
Converting Machine				Loom (textile).....	1.50	2.00	1.25	Windlass	1.50	2.00	1.25
(paper).....	1.50	2.00	1.25	Machine Tools,				Wire			
Conveyors				Main Drives	1.50	2.00	1.25	Drawing.....	2.00	2.50	1.50
Apron, Assembly, Belt,				Mangle (textile).....	1.25	1.50	1.00	Winding.....	1.50	2.00	1.25
Flight, Oven, Screw.....	1.25	1.50	1.00	Mash Tubs (distilling).....	1.25	1.50	1.00	Woodworking			
Bucket	1.50	2.00	1.25	Meat Grinder	1.50	2.00	1.25	Machinery.....	1.25	1.50	1.00
Cookers—Brewing,				Metal Forming							
Distilling, Food	1.25	1.50	1.00	Machines	1.50	2.00	1.25				
Cooling Tower Fans	2.00	2.50	1.50	Mills							
Couch (paper).....	1.50	2.00	1.25	Ball, Pebble, Rod, Tube,							
Cranes & Hoists ¹				Rubber, Tumbling.....	2.00	2.50	1.50				
Heavy duty mine.....	2.00	2.50	1.50	Dryers, Coolers.....	1.50	2.00	1.25				
Crushers—Cane (sugar),				Mixers							
Stone, Ore	2.00	2.50	1.50	Concrete, Muller.....	1.50	2.00	1.25				
Cutter-Paper	2.00	2.50	1.50	Banbury.....	2.00	2.50	1.50				
Cylinder (paper).....	2.00	2.50	1.50	Ore Crusher	2.00	2.50	1.50				
Dewatering Screen				Oven Conveyor	1.25	1.50	1.00				
(sewage).....	1.50	2.00	1.25	Planer (metal or wood).....	1.50	2.00	1.25				

Caution: Applications involving reciprocating engines and reciprocating driven devices are subject to critical rotational speeds which may damage the coupling and/or connected equipment. Contact Lovejoy Engineering with specific requirements.

Note: ■ 1 indicates: If people are transported, Lovejoy does not recommend and will not warranty the use of the coupling.

Nomenclature

A complete standard coupling unit consists of two hubs and one insert.

Hubs

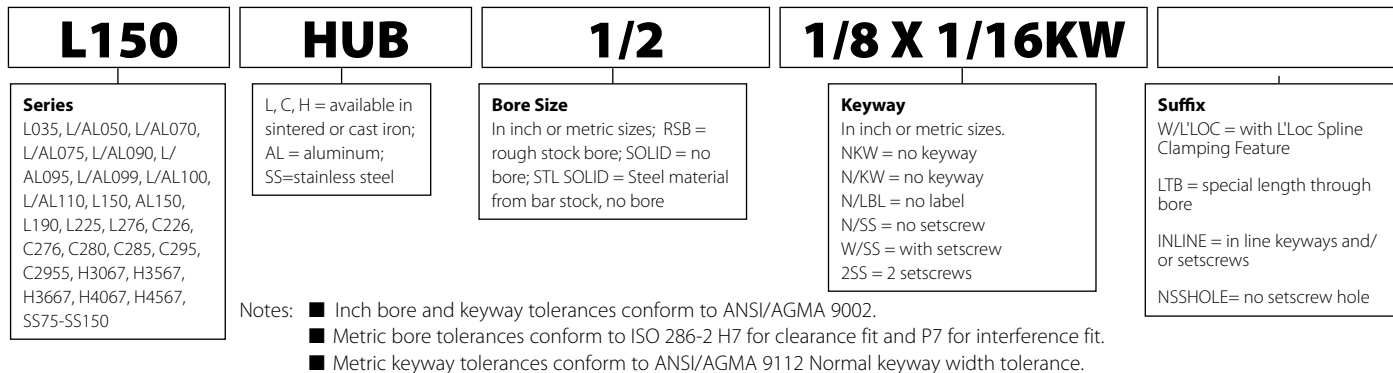

Inserts

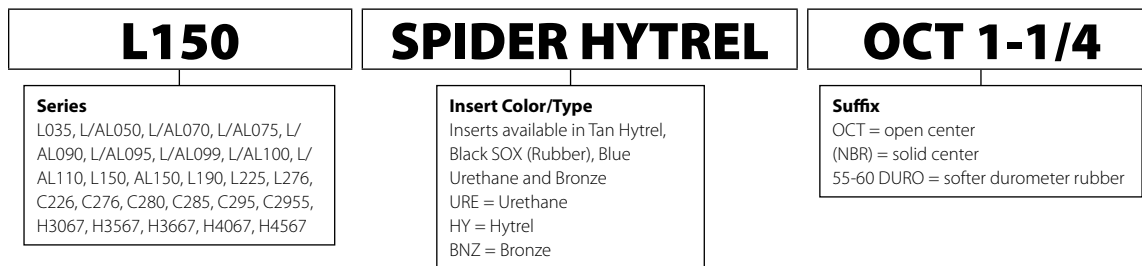

Snap Wraps

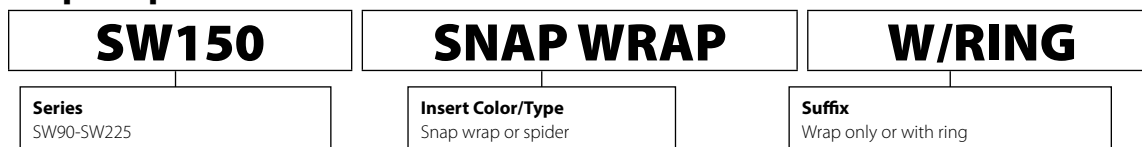

Cushions (C&H Type)

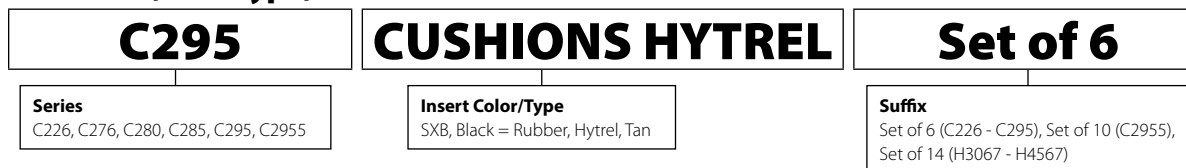

Collars and Kits

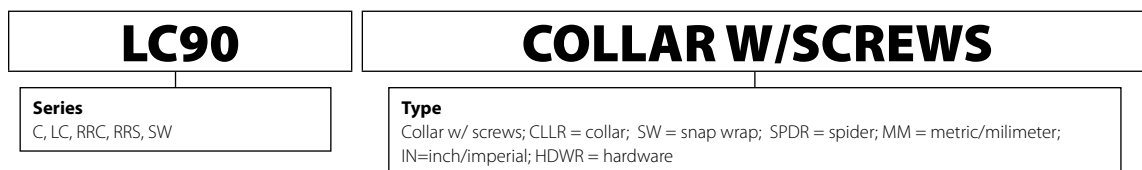

Spacers and Spacer Assembly

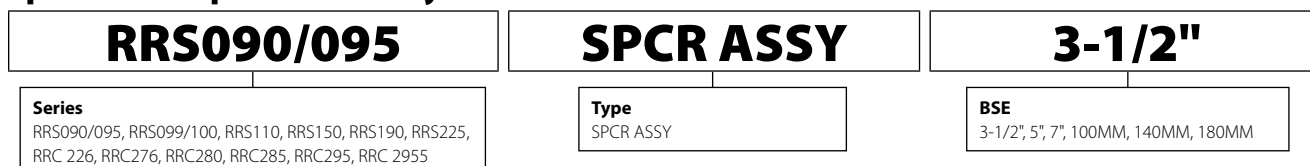

Performance Data

JW

Spider Performance Data

Chart 2

Characteristics	Temperature Range	Misalignment		Shore Hardness ¹	Dampening Capacity	Chemical Resistance ²	Color
		Angular Degree	Parallel Inch				
SOX (NBR) Rubber – Nitrile Butadiene (Buna N) Rubber is a flexible elastomer material that is oil resistant, resembles natural rubber in resilience and elasticity and operates effectively in temperature range of -40° to 212° F (-40° to 100° C). Good resistance to oil. Standard elastomer. (Also applies to SXB Cushions.)	-40° to 212° F -40° to 100° C	1°	.015	80A	HIGH	GOOD	BLACK
URETHANE – Urethane has greater torque capability than NBR (1.5 times), provides less dampening effect, and operates at a temperature range of -30° to 160° F (-34° to 71° C). Good resistance to oil and chemicals. Not recommended for cyclic or start/stop applications.	-30° to 160° F -34° to 71° C	1°	.015	55D L050-L110 90-95A L150-L225	LOW	VERY GOOD	BLUE
HYTREL® – Hytrel is a flexible elastomer designed for high torque and high temperature operations. Hytrel can operate in temperatures of -60° to 250° F (-51° to 121° C) and has an excellent resistance to oil and chemicals. Not recommended for cyclic or start/stop applications.	-60° to 250° F -51° to 121° C	1/2°	.015	55D	LOW	EXCELLENT	TAN
BRONZE – Bronze is a rigid, porous oil-impregnated metal insert exclusively for slow speed (maximum 250 RPM) applications requiring high torque capabilities. Bronze operations are not affected by extreme temperatures, water, oil, or dirt.	-40° to 450° F -40° to 232° C	1/2°	.010	—	NONE	EXCELLENT	BRONZE

Notes: ■ 1 indicates: NBR standard shore hardness is 80A ±5A – Except L035=60A. Other softer or harder designs are available in NBR material; consult Lovejoy.
 ■ 2 indicates: Chemical Resistance chart shown in Engineering Data Section (page ED-9).

Jaw Nominal Rated Torque Data

Chart 3

Size	Max Bore		Spider Material							
	in	mm	SOX (NBR) Torque		Urethane Torque		Hytrel Torque		Bronze Torque	
			in-lbs	Nm	in-lbs	Nm	in-lbs	Nm	in-lbs	Nm
L035	0.375	9	3.5	0.4	—	—	—	—	—	—
L/AL050	0.625	16	26.3	3.0	39	4.5	50	5.60	50	5.60
L/AL070	0.750	19	43.2	4.9	65	7.3	114	12.90	114	12.90
L/AL075	0.875	22	90.0	10.2	135	15.3	227	25.60	227	25.60
L/AL090	1.000	25	144.0	16.3	216	24.4	401	45.30	401	45.30
L/AL095	1.125	28	194.0	21.9	291	32.9	561	63.40	561	63.40
L/AL099	1.188	30	318.0	35.9	477	53.9	792	89.50	792	89.50
L/AL100	1.375	35	417.0	47.1	626	70.7	1,134	128.00	1,134	128.00
L/AL110	1.625	42	792.0	89.5	1,188	134.0	2,268	256.00	2,268	256.00
L150	1.875	48	1,240.0	140.0	1,860	210.0	3,708	419.00	3,706	419.00
AL150	1.875	48	1,450.0	163.8	—	—	—	—	—	—
L190	2.125	55	1,728.0	195.0	2,592	293.0	4,680	529.00	4,680	529.00
L225	2.625	65	2,340.0	264.0	3,510	397.0	6,228	704.00	6,228	704.00
L276	2.875	73	4,716.0	533.0	—	—	—	—	12,500	1 412.00
C226	2.500	64	2,988.0	338.0	—	—	5,940	671.00	5,940	671.00
C276	2.875	73	4,716.0	533.0	—	—	9,432	1 066.00	—	—
C280	3.000	76	7,560.0	854.0	—	—	13,866	1 567.00	—	—
C285	4.000	102	9,182.0	1 038.0	—	—	16,680	1 882.00	—	—
C295	3.500	89	11,340.0	1 281.0	—	—	22,680	2 563.00	22,680	2 563.00
C2955	4.000	102	18,900.0	2 136.0	—	—	37,800	4 271.00	37,800	4 271.00
H3067	4.500	114	33,395.0	3 774.0	—	—	47,196	5 333.00	47,196	5 333.00
H3567	5.000	127	46,632.0	5 269.0	—	—	63,000	7 119.00	63,000	7 119.00
H3667	5.629	143	64,812.0	7 323.0	—	—	88,200	9 966.00	88,200	9 966.00
H4067	6.250	159	88,224.0	9 969.0	—	—	126,000	14 237.00	126,000	14 237.00
H4567	7.000	178	119,700.0	13 525.0	—	—	170,000	19 209.00	170,000	19 209.00

Note: ■ Bronze has a maximum RPM capability of 250 RPM.

L Type Spiders / Hub Spline Bores Item Selection

JW

L Type Coupling

- Sizes range from L035 to L276
- Ordering requires selecting UPC numbers for two standard L hubs and one standard open or solid center elastomer (spider)

SW Type Coupling

- Sizes range from L090 to L190
- Ordering requires selecting UPC numbers for two standard L hubs and one snap wrap spider with snap ring
- Both L and SW Type couplings, select hubs from the standard bore and keyway chart (pages JW-11 and JW-12) maximum RPM for SW + Ring is 1,750 RPM
- LC coupling uses a snap wrap spider with a collar instead of a retaining ring



Jaw In-Shear Coupling

- Ordering requires selecting item numbers for two standard hubs, one In-Shear elastomer and one In-Shear ring. See pages JIS-1 through JIS-4

L Type Spider UPC Number Selection Table

Spider Type	Coupling Size										
	L035	L050	L070	L075	L090/095	L099/100	L110	L150	L190	L225	L276
SOX (NBR) (Solid)	10118	10194	10406	10621	11070	11494	11724	12001	12274	12409	—
SOX (NBR) (open center)	—	—	10393	10620	10968	11492	11711	37880	37881	12406	12612
Urethane (Solid)	—	37786	10395	—	—	—	—	—	—	—	—
Urethane (open center)	—	—	10411	10626	11075	11499	11729	12006	12280	12417	—
Hytrel® (Solid)	—	25307	—	—	—	—	11717	11993	12265	12401	—
Hytrel® (open center)	—	—	25308	25309	25310	11486	38097	38098	38099	12400	—
Bronze (open center)	—	10198	10409	10624	11073	11497	11727	12004	12277	34517	25767
Snap Wrap (NBR) w/ring	—	—	—	—	24669	24670	24671	24672	24673	—	—
Snap Wrap (NBR) w/o ring	—	—	—	—	11071	11495	11725	12002	12275	—	—
SOX (NBR) Bulk - pk 25	50115	50116	50117	50118	50119	—	—	—	—	—	—
SOX (NBR) Bulk - pk 10	—	—	—	—	—	50120	50121	50122	—	—	—
Snap Wrap Urethane - solid ring	—	—	—	—	—	41170	41171	—	—	26093	—
In-Shear Elastomer	—	—	—	—	71706	71707	71708	71709	71710	71711	71712
In-Shear Ring	—	—	—	—	71679	71680	71681	71682	71683	71684	71685

Note: ■ When referencing the Lovejoy UPC number in this table, include 685144 as a prefix to the number shown.

L Type Hub - Spline Bore UPC Number Selection Table

Teeth	Pitch	SAE	Spline Bore Diameters		Major Dia	Coupling Size								
			Major	Minor		L090	L095	L099	L100	L110	L150	L190	L225	L276
9	16/32	A	0.651	0.509	0.625	38568	37900	38571	37904	—	—	—	—	—
11	16/32		0.776	0.631	0.750	38569	37901	38572	37905	37909	37917	37925	—	—
13	16/32	B	0.901	0.754	0.875	38570	37902	38573	37906	37910	37918	37926	37935	—
13	8/16	D, E	1.798	1.506	1.750	—	—	—	—	37915	37923	37931	37940	38576
14	12/24	C	1.289	1.087	1.250	—	—	—	—	37912	37920	37928	37937	38577
15	16/32	BB	1.026	0.877	1.000	—	—	38574	37907	37911	37919	37927	37936	38578
21	16/32		1.401	1.250	1.375	—	—	—	—	37913	37921	37929	37938	—
23	16/32		1.526	1.375	1.500	—	—	—	—	37914	37922	37930	37939	—
27	16/32		1.776	1.625	1.750	—	—	—	—	37916	37924	37932	37941	38579
15	8/16	F	2.048	1.753	2.000	—	—	—	—	—	—	37933	37942	—

- Notes: ■ All pressure angles on above splines = 30°. Class 5 fit is standard, unless otherwise specified.
 ■ All stock spline bore hubs are supplied standard with Lovejoy's exclusive L-LOC Clamping Feature. See page T-7 for description.
 ■ When referencing the Lovejoy UPC number in this table, include 685144 as a prefix to the number shown.

L Type Inch Bore / Keyway Item Selection

JW

The L Type coupling consists of two standard L Type hubs and one spider. Refer to pages JW-11, JW-12, and JW-10.



L-Type Hub (Imperial) UPC Selection Table

Bore	Keyway	L035	L050	L070	L075	L090	L095	L099	L100	L110	L150	L190	L225	L276
1/8	No Keyway	10124	—	—	—	—	—	—	—	—	—	—	—	—
3/16	No Keyway	10126	—	—	—	—	—	—	—	—	—	—	—	—
1/4	No Keyway	10127	10206	10416	10680	10766	—	—	—	—	—	—	—	—
1/4	1/8 x 1/16	—	—	—	35744	—	—	—	—	—	—	—	—	—
5/16	No Keyway	10128	10207	10417	10681	26209	—	—	—	—	—	—	—	—
3/8	No Keyway	24687	10208	10418	10682	10767	—	—	—	—	—	—	—	—
3/8	3/32 x 3/64	—	46121	41985	37234	37235	—	—	—	—	—	—	—	—
3/8	1/8 x 1/16	—	44136	48829	35745	37236	—	—	—	—	—	—	—	—
7/16	No Keyway	—	10209	10419	10683	10768	11082	31297	11505	—	—	—	—	—
7/16	3/32 x 3/64	—	44713	44007	28089	28877	27613	38198	37237	—	—	—	—	—
7/16	1/8 x 1/16	—	—	44066	28875	28878	28879	38199	37238	—	—	—	—	—
1/2	No Keyway	—	10210	10420	10684	10769	11083	11333	11506	—	—	—	—	—
1/2	1/8 x 1/16	—	10211	10421	10685	26087	26088	11334	26089	—	—	—	—	—
9/16	No Keyway	—	10212	52338	10686	24976	37239	11335	11508	—	—	—	—	—
9/16	1/8 x 1/16	—	10213	10423	10687	28876	11084	38200	11509	—	—	—	—	—
5/8	No Keyway	—	10214	24771	44322	46052	41911	44174	44291	11733	12101	—	—	—
5/8	5/32 x 5/64	—	—	51104	37240	37241	37242	38201	37243	37244	37245	—	—	—
5/8	3/16 x 3/32	—	—	10424	10688	10771	11085	11336	11510	26211	26212	—	—	—
11/16	3/16 x 3/32	—	—	10425	10689	10772	11086	11337	11511	11734	12102	—	—	—
3/4	No Keyway	—	—	46116	56140	54282	56887	49705	45212	—	—	12285	12422	—
3/4	1/8 x 1/16	—	—	51719	35881	37246	37074	38202	37247	37248	37249	37250	—	—
3/4	3/16 x 3/32	—	—	10426	10690	10773	11087	11338	11512	11735	12103	38468	35882	—
13/16	3/16 x 3/32	—	—	—	10691	10774	11088	11339	11513	11736	12104	37252	37255	—
7/8	No Keyway	—	—	—	56941	—	—	59063	—	—	—	—	—	12582
7/8	3/16 x 3/32	—	—	—	10692	10775	11089	11340	11514	11737	12105	12286	12423	12585
7/8	1/4 x 1/8	—	—	—	—	38188	35747	38203	35686	35749	35750	37256	35753	54883
15/16	1/4 x 1/8	—	—	—	—	32332	11090	11341	11515	11738	12160	12287	12424	—
1	1/4 x 1/8	—	—	—	—	31296	11091	11342	11516	11739	12107	12288	12425	12586
1	3/16 x 3/32	—	—	—	—	37257	37258	38204	37259	37260	37261	37262	37263	—
1-1/16	1/4 x 1/8	—	—	—	—	—	11092	11343	11517	11740	12108	12289	12426	—
1-1/8	1/4 x 1/8	—	—	—	—	—	11093	11344	11518	11741	12109	12290	12427	12587
1-3/16	1/4 x 1/8	—	—	—	—	—	—	11345	11519	11742	12110	12291	12428	—
1-1/4	1/4 x 1/8	—	—	—	—	—	—	—	11520	11743	12111	12292	12429	12588
1-1/4	5/16 x 5/32	—	—	—	—	—	—	—	35748	35752	35751	37294	35754	12589
1-5/16	5/16 x 5/32	—	—	—	—	—	—	—	11521	11744	12112	12293	26090	—
1-3/8	5/16 x 5/32	—	—	—	—	—	—	—	11522	11745	12113	12294	12430	12590
1-3/8	3/8 x 3/16	—	—	—	—	—	—	—	44348	37265	37266	37267	37268	46758
1-7/16	3/8 x 3/16	—	—	—	—	—	—	—	—	11746	12114	12295	12431	12591
1-1/2	5/16 x 5/32	—	—	—	—	—	—	—	—	37269	37270	37271	37272	—
1-1/2	3/8 x 3/16	—	—	—	—	—	—	—	—	11747	12115	12296	12432	12592
1-9/16	3/8 x 3/16	—	—	—	—	—	—	—	—	11748	12116	37273	12433	45689
1-5/8	3/8 x 3/16	—	—	—	—	—	—	—	—	11749	12117	12297	12434	12593
1-11/16	3/8 x 3/16	—	—	—	—	—	—	—	—	—	12118	12298	12435	60057
1-3/4	3/8 x 3/16	—	—	—	—	—	—	—	—	—	12119	12299	12436	12594
1-3/4	7/16 x 7/32	—	—	—	—	—	—	—	—	—	37274	37275	37276	48250
1-13/16	1/2 x 1/4	—	—	—	—	—	—	—	—	—	12120	12300	26091	—
1-7/8	1/2 x 1/4	—	—	—	—	—	—	—	—	—	12121	12301	12437	12595
1-15/16	1/2 x 1/4	—	—	—	—	—	—	—	—	—	—	12302	12438	49762
2	1/2 x 1/4	—	—	—	—	—	—	—	—	—	—	12303	12439	12596
2-1/16	1/2 x 1/4	—	—	—	—	—	—	—	—	—	—	12304	26092	—
2-1/8	1/2 x 1/4	—	—	—	—	—	—	—	—	—	—	12305	12440	12597
2-3/16	1/2 x 1/4	—	—	—	—	—	—	—	—	—	—	—	12441	12598
2-1/4	1/2 x 1/4	—	—	—	—	—	—	—	—	—	—	—	12442	12599
2-3/8	5/8 x 5/16	—	—	—	—	—	—	—	—	—	—	—	12443	12600
2-5/8	5/8 x 5/16	—	—	—	—	—	—	—	—	—	—	—	41809	12601
2-7/8	3/4 x 3/8	—	—	—	—	—	—	—	—	—	—	—	—	12605

Notes: ■ Tolerances for bore and keyways are found in Engineering Data section (pages ED-10 and ED-11). All hubs supplied standard with one set screw.

■ Non-standard bores available – consult Lovejoy Engineering.

■ When referencing the Lovejoy UPC number in this table, include 685144 as a prefix to the number shown.

L Type Metric Bore / Keyway Item Selection

The L Type coupling consists of two standard L Type hubs and one spider. Refer to pages JW-11, JW-13, and JW-11.



JW

L Type Hub - Metric Bore and Keyway UPC Number Selection Table

Bore	Keyway	L035	L050	L070	L075	L090	L095	L099	L100	L110	L150	L190	L225	L276
4	No Keyway	41850	—	—	—	—	—	—	—	—	—	—	—	—
5	No Keyway	47419	46214	—	—	—	—	—	—	—	—	—	—	—
6	No Keyway	45872	50351	—	—	—	—	—	—	—	—	—	—	—
7	No Keyway	60679	10215	58803	—	—	—	—	—	—	—	—	—	—
8	No Keyway	55169	41460	46151	—	60945	—	—	—	—	—	—	—	—
9	3 x 1.4	—	41313	56177	44298	—	—	—	—	—	—	—	—	—
10	No Keyway	—	10216	41452	41456	—	—	—	—	—	—	—	—	—
10	3 x 1.4	—	41450	49870	41457	52828	—	—	—	—	—	—	—	—
11	4 x 1.8	—	41314	41453	50811	—	49424	—	—	—	—	—	—	—
12	No Keyway	—	48510	51562	—	48276	—	—	—	—	—	—	—	—
12	4 x 1.8	—	41315	41454	44153	44329	44832	—	55195	—	—	—	—	—
14	No Keyway	—	58036	47505	—	41461	41465	—	—	—	—	—	—	—
14	5 x 2.3	—	41316	41317	41321	51231	41466	60094	45101	—	—	—	—	—
15	No Keyway	—	60708	—	10693	—	46561	52697	41469	—	—	—	—	—
15	5 x 2.3	—	41451	41455	41454	52096	45778	46972	47123	—	—	—	—	—
16	5 x 2.3	—	56176	41318	41322	49198	41325	52098	55534	52092	52471	—	—	—
17	5 x 2.3	—	—	45333	49398	—	49704	—	56178	60067	60156	—	—	—
18	6 x 2.8	—	—	59724	41884	46433	46626	44647	41926	44288	—	—	—	—
19	No Keyway	—	—	—	—	10777	—	—	—	41471	—	—	—	—
19	6 x 2.8	—	—	41319	41323	41462	41326	44157	41329	49700	48821	46717	—	—
20	6 x 2.8	—	—	—	41459	41925	41467	47122	52093	41804	61218	61497	—	—
22	6 x 2.8	—	—	—	58246	41968	44827	41959	44467	45214	44720	—	—	—
24	8 x 3.3	—	—	—	—	41463	41327	41990	41330	48301	48182	59109	—	—
25	8 x 3.3	—	—	—	—	41464	41468	45055	41470	41906	46751	52153	—	—
28	No Keyway	—	—	—	—	—	—	—	—	—	56179	56182	—	—
28	8 x 3.3	—	—	—	—	—	41328	50103	41331	41333	45679	52976	—	—
30	8 x 3.3	—	—	—	—	—	—	47132	48317	45681	41738	44471	48982	—
32	No Keyway	—	—	—	—	—	—	—	—	—	41472	41473	48319	56232
32	10 x 3.3	—	—	—	—	—	—	—	—	41334	41873	45562	41849	41885
35	No Keyway	—	—	—	—	—	—	—	41332	—	56180	56183	56184	—
35	10 x 3.3	—	—	—	—	—	—	—	49925	45682	46562	58035	52197	—
38	10 x 3.3	—	—	—	—	—	—	—	—	41335	41337	41474	49664	52961
40	12 x 3.3	—	—	—	—	—	—	—	—	45683	48318	48320	49605	59308
42	12 x 3.3	—	—	—	—	—	—	—	—	41336	41338	41475	47492	45609
45	14 x 3.8	—	—	—	—	—	—	—	—	—	45102	56017	52674	50292
48	No Keyway	—	—	—	—	—	—	—	—	—	56181	—	—	—
48	14 x 3.8	—	—	—	—	—	—	—	—	—	56227	48322	47569	61202
50	No Keyway	—	—	—	—	—	—	—	—	—	—	56228	56230	56233
50	14 x 3.8	—	—	—	—	—	—	—	—	—	—	44392	48797	45062
55	No Keyway	—	—	—	—	—	—	—	—	—	—	56229	56231	56234
55	16 x 4.3	—	—	—	—	—	—	—	—	—	—	47006	44089	56067
60	No Keyway	—	—	—	—	—	—	—	—	—	—	—	56185	56235
60	18 x 4.4	—	—	—	—	—	—	—	—	—	—	—	44598	56236
65	No Keyway	—	—	—	—	—	—	—	—	—	—	—	—	56237
65	18 x 4.4	—	—	—	—	—	—	—	—	—	—	—	56544	50102
70	20 x 4.9	—	—	—	—	—	—	—	—	—	—	—	—	58268

Notes: ■ Tolerances for bore and keyways are found in Engineering Data section (page ED-17 and ED-18). All hubs supplied standard with one set screw.
 ■ Non-standard bores available – consult Lovejoy Engineering.
 ■ When referencing the Lovejoy UPC number in this table, include 685144 as a prefix to the number shown.

LC Type / Inch Bore / Keyway

Item Selection

JW

LC Type Couplings

The LC Type coupling consists of one standard L Type hub (without collar attachment), one LC Type hub (provides collar attachment), one standard snap wrap center and one collar with screws. Refer to pages JW-12, JW-13 and JW-14 for details.



Features

- Radially removable insert
- Collar allows for maximum speed of 3,600 RPM
- Collar manufactured from 1018 Steel

LC Type Hub - Inch Bore and Keyway UPC Number Selection Table

Bore	Keyway	LC090	LC095	LC099	LC100	LC110	LC150	LC190	LC225
1/4	No Keyway	45321	—	—	—	—	—	—	—
3/8	No Keyway	45322	—	—	—	—	—	—	—
1/2	No Keyway	45323	11133	—	11575	—	—	—	—
1/2	1/8 x 1/16	—	—	—	48768	—	—	—	—
5/8	No Keyway	—	—	—	—	11828	45412	—	—
5/8	3/16 x 3/32	45324	11134	48886	11577	—	—	—	—
3/4	No Keyway	—	—	—	—	—	—	12322	12456
3/4	1/8 x 1/16	—	—	—	55466	—	—	—	—
3/4	3/16 x 3/32	45325	11135	—	41920	11829	—	12323	—
13/16	3/16 x 3/32	—	11136	—	—	11830	—	—	—
7/8	3/16 x 3/32	45326	11137	—	11578	11832	—	—	—
7/8	1/4 x 1/8	—	—	56567	49553	56566	60343	—	—
15/16	1/4 x 1/8	—	11138	—	—	11834	—	—	—
1	1/4 x 1/8	45327	11139	52825	11579	11836	12069	44161	50125
1	3/16 x 3/32	—	—	—	—	55552	—	—	—
1-1/8	1/4 x 1/8	—	44156	—	11580	11838	12071	44160	50126
1-3/16	1/4 x 1/8	—	11140	—	—	11840	—	—	—
1-1/4	1/4 x 1/8	—	—	—	11581	11841	12073	12327	12462
1-1/4	5/16 x 5/32	—	—	—	59046	—	48273	—	—
1-3/8	5/16 x 5/32	—	—	—	45257	11842	12075	12329	50127
1-7/16	3/8 x 3/16	—	—	—	—	11844	—	—	12465
1-1/2	5/16 x 5/32	—	—	—	—	—	12077	—	—
1-1/2	3/8 x 3/16	—	—	—	—	11846	—	12332	12466
1-9/16	3/8 x 3/16	—	—	—	—	11848	—	12332	—
1-5/8	3/8 x 3/16	—	—	—	—	11849	12079	12334	12468
1-3/4	3/8 x 3/16	—	—	—	—	—	44159	12336	46818
1-7/8	1/2 x 1/4	—	—	—	—	—	12082	12337	12472
1-15/16	1/2 x 1/4	—	—	—	—	—	—	12339	—
2	1/2 x 1/4	—	—	—	—	—	—	12341	14276
2-1/8	1/2 x 1/4	—	—	—	—	—	—	44064	12477
2-1/4	1/2 x 1/4	—	—	—	—	—	—	—	12480
2-3/8	5/8 x 5/16	—	—	—	—	—	—	—	12482

- Notes:
- These "LC" hubs are drilled and tapped to accept collar mounting screws but the collar and hardware are not included.
 - See L Type (inch or metric) coupling chart for standard hub.
 - Tolerances for bore and keyways are found in Engineering Data section (pages ED-10 and ED-11).
 - All hubs are supplied standard with one set screw.
 - When referencing the Lovejoy UPC number in this table, include 685144 as a prefix to the number shown.

LC Type Spiders / Metric Bore / Keyway Item Selection

LC Type Couplings

The LC Type coupling consists of one standard L Type hub (without collar attachment), one LC Type hub (provides collar attachment), one standard snap wrap center and one collar with screws. Refer to pages JW-12, JW-13 and JW-14 for details.



JW

Features

- Radially removable insert
- Collar allows for maximum speed of 3,600 RPM
- Collar manufactured from 1018 Steel

LC Type Wrap Spider / Collar UPC Number Selection Table

	LC090	LC095	LC099	LC100	LC110	LC150	LC190	LC225
Snap Wrap Spider/No Ring	11071	11071	11495	11495	11725	12002	12275	26093 ¹
Collar Only w/Screws	48340	48340	45258	45258	47932	47933	47934	47935

Notes: ■ 1 indicates: L225 snap wrap spider is urethane, solid ring.
 ■ When referencing the Lovejoy UPC number in this table, include 685144 as a prefix to the number shown.

LC Type Hub - Metric Bore and Keyway UPC Number Selection Table

Bore	Keyway	LC090	LC095	LC099	LC100	LC110	LC150	LC190	LC225
12	No Keyway	58596	—	—	—	—	—	—	—
12	4 x 1.8	58597	—	—	—	—	—	—	—
14	No Keyway	58598	58592	—	—	—	—	—	—
14	5 x 2.3	58556	58559	—	—	—	—	—	—
15	5 x 2.3	58599	—	—	—	—	—	—	—
16	5 x 2.3	—	58593	—	—	—	—	—	—
19	6 x 2.8	58557	58560	56197	58563	58566	—	—	—
20	6 x 2.8	—	58594	—	—	—	—	—	—
24	8 x 3.3	58558	58561	58588	58564	58567	—	—	—
25	8 x 3.3	58600	58595	58589	—	—	—	—	—
28	8 x 3.3	—	58562	58590	58565	58568	58571	58575	—
32	10 x 3.3	—	—	—	52806	58587	58585	58586	—
38	10 x 3.3	—	—	—	—	58569	58572	58576	58580
42	12 x 3.3	—	—	—	—	58570	58573	58577	58581
48	14 x 3.8	—	—	—	—	—	58574	58578	58582
55	16 x 4.3	—	—	—	—	—	—	58579	58583
65	No Keyway	—	—	—	—	—	—	—	58584

Notes: ■ These "LC" hubs are drilled and tapped to accept collar mounting screws but the collar and hardware are not included.
 ■ See L Type (inch or metric) UPC Number Selection Table for standard hub (pages JW-12 or JW-11).
 ■ Tolerances for bore and keyways are found in Engineering Data section (pages ED-17 and ED-18).
 ■ All hubs are supplied with one set screw.
 ■ When referencing the Lovejoy UPC number in this table, include 685144 as a prefix to the number shown.

AL and SS Type / Inch Bore / Keyway Item Selection

JW

AL and SS Type Couplings

The AL Type coupling consists of two hubs and one spider.

Features

- Interchangeable with all hub sizes standard for the L-Line and AL-Line products
- Available in a variety of different finished bore and keyway combinations
- Finished bores passivated for additional rust protection



AL Type Hub - Inch Bore and Keyway UPC Number Selection Table

Bore	Keyway	AL050	AL070	AL075	AL090	AL095	AL099	AL100	AL110	AL150
1/4	No Keyway	10252	10463	10630	10791	—	—	—	—	—
5/16	No Keyway	10253	10464	10631	10792	—	—	—	—	—
3/8	No Keyway	10254	10466	10632	10793	—	—	—	—	—
7/16	No Keyway	10256	10469	10633	10794	—	—	—	—	—
1/2	No Keyway	10257	10471	10634	10795	17847	17880	17914	—	—
1/2	1/8 x 1/16	49706	10473	10635	10796	17848	17881	17915	—	—
9/16	No Keyway	—	—	10637	10797	—	—	56473	—	—
9/16	1/8 x 1/16	—	—	10638	4412	37994	44323	17917	—	—
5/8	No Keyway	10259	10480	61817	44004	—	—	—	17977	18035
5/8	3/16 x 3/32	—	10482	10639	10798	17855	17882	17918	38888	44828
11/16	3/16 x 3/32	—	—	45227	10799	17851	45494	17919	44059	46642
3/4	1/8 x 1/16	—	—	47835	47725	46295	—	—	—	—
3/4	3/16 x 3/32	—	10491	10640	10800	17852	17883	17920	17978	18036
13/16	3/16 x 3/32	—	—	10641	10801	17853	17884	17921	—	—
7/8	3/16 x 3/32	—	—	10642	10802	17854	17885	17922	17979	18037
15/16	1/4 x 1/8	—	—	—	—	17855	17886	17923	17980	18038
1	1/4 x 1/8	—	—	—	—	17856	17887	17924	17981	18039
1-1/16	1/4 x 1/8	—	—	—	—	17857	17888	17925	26094	18040
1-1/8	1/4 x 1/8	—	—	—	—	17858	17889	17926	17982	18041
1-3/16	1/4 x 1/8	—	—	—	—	—	17890	17927	17983	18042
1-1/4	1/4 x 1/8	—	—	—	—	—	—	17928	17984	18043
1-5/16	5/16 x 5/32	—	—	—	—	—	—	17929	17985	18044
1-3/8	5/16 x 5/32	—	—	—	—	—	—	17930	17986	18045
1-7/16	3/8 x 3/16	—	—	—	—	—	—	45508	17987	18046
1-1/2	3/8 x 3/16	—	—	—	—	—	—	—	17988	18047
1-9/16	3/8 x 3/16	—	—	—	—	—	—	—	17989	18048
1-5/8	3/8 x 3/16	—	—	—	—	—	—	—	17990	18049
1-11/16	3/8 x 3/16	—	—	—	—	—	—	—	—	18050
1-3/4	3/8 x 3/16	—	—	—	—	—	—	—	—	18051
1-13/16	1/2 x 1/4	—	—	—	—	—	—	—	—	18052
1-7/8	1/2 x 1/4	—	—	—	—	—	—	—	—	18053

- Notes:
- Tolerances for bore and keyways are found in Engineering Data section (page ED-10).
 - Lovejoy does not recommend reborring AL hubs.
 - All hubs are supplied standard with one set screw, except the AL150 which is provided with two set screws.
 - When referencing the Lovejoy UPC number in this table, include 685144 as a prefix to the number shown.

SS Type Hub - Inch Bore and Keyway UPC Number Selection Table

Size	RSB	1/4	1/2	5/8	3/4	7/8	1	1-1/8	1-3/8	1-1/2
SS075	70001	70006	70007	70008	70009	70010	—	—	—	—
SS095	70002	70011	70011	70012	70013	70014	70015	70016	—	—
SS100	70003	—	—	—	70017	70018	70019	70020	70022	—
SS110	70004	—	—	—	—	—	70023	70024	70026	70027
SS150	70005	—	—	—	—	—	70029	70030	70032	70033

- Note:
- When referencing the Lovejoy UPC number in this table, include 685144 as a prefix to the number shown.



AL Type Spiders / Metric Bore / Keyway Item Selection

AL Type Couplings

The AL Type coupling consists of two hubs and one spider. Refer to page JW-11 for spider details.



JW

Features

- Aluminum material is corrosion resistant
- Lightweight
- Hubs compatible with standard Lovejoy hub design (except AL150)

AL Type Spider UPC Number Selection Table

Spider Type	AL050	AL070	AL075	AL090/095	AL099/100	AL110	AL150
SOX (NBR) (solid)	10194	10406	10621	11070	11494	11724	18027
SOX (NBR) (open center)	—	10393	10620	10968	11492	11711	—
Urethane (solid)	37786	10395	—	—	—	—	—
Urethane (open center)	—	10411	10626	11075	11499	11729	—
Hytrel (solid)	25307	—	—	—	—	11717	—
Hytrel (open center)	—	25308	25309	25310	11486	38097	—
Bronze (open center)	10198	10409	10624	11073	11497	11727	—
Snap Wrap w/ring	—	—	—	24669	24670	24671	—
Snap Wrap no ring	—	—	—	11071	11495	11725	—

- Notes: ■ AL Type couplings use the same spiders as L Type couplings, except AL150 which has four jaws instead of three.
 ■ When referencing the Lovejoy UPC number in this table, include 685144 as a prefix to the number shown.

AL Type Hub - Metric Bore and Keyway UPC Number Selection Table

Bore	Keyway	AL050	AL070	AL075	AL090	AL095	AL099	AL100	AL110	AL150
8	No Keyway	—	—	48973	—	—	—	—	—	—
10	3 x 1.4	—	—	41924	56514	—	—	—	—	—
11	4 x 1.8	—	65694	51098	58620	—	—	—	—	—
12	4 x 1.8	—	56487	64655	60429	—	—	—	—	—
14	5 x 2.3	—	65696	47302	58621	56800	58624	—	—	—
15	5 x 2.3	—	62906	49633	58622	56801	—	49629	—	—
16	5 x 2.3	—	—	52221	—	47014	—	45012	—	—
17	5 x 2.3	—	—	—	60887	44712	—	59164	—	—
19	6 x 2.8	—	65698	47427	44679	47012	58625	47253	59064	—
20	No Keyway	—	—	56137	—	—	—	—	—	—
20	6 x 2.8	—	—	59394	61478	48347	49634	49630	49631	60878
22	6 x 2.8	—	—	—	—	47013	—	—	—	—
24	8 x 3.3	—	—	—	—	45736	58626	44058	45690	64634
25	8 x 3.3	—	—	—	—	65469	49709	55687	45933	64633
28	8 x 3.3	—	—	—	—	47015	58627	47393	45463	—
30	8 x 3.3	—	—	—	—	—	52048	58266	49632	45063
32	10 x 3.3	—	—	—	—	—	—	—	54417	44347
35	10 x 3.3	—	—	—	—	—	—	—	46215	64803
36	10 x 3.3	—	—	—	—	—	—	—	—	51737
38	10 x 3.3	—	—	—	—	—	—	—	52692	58215
42	12 x 3.3	—	—	—	—	—	—	—	—	45404
46	14 x 3.8	—	—	—	—	—	—	—	—	64119

- Notes: ■ Tolerances for bore and keyways are found in Engineering Data section (page ED-17).
 ■ Lovejoy does not recommend reboring AL hubs.
 ■ All hubs are supplied standard with one set screw, except the AL150 which is provided with two set screws.
 ■ When referencing the Lovejoy UPC number in this table, include 685144 as a prefix to the number shown.

RRS and RRSC Type / Inch Bore / Keyway Item Selection

JW

RRS Type couplings range from sizes RRS090 to RRS225. The RRS Type coupling consists of:

RRS090 – RRS110:

- 2 Standard RRS Hubs
- 1 Spacer Assembly consisting of:
 - 2 snap wrap spiders w/o ring
 - 2 collars with screws
 - 1 spacer

RRS150 – RRS225:

- 1 Standard RRS Hub
- 1 Standard RRSC Hub – Drilled for collar
- 1 Spacer Assembly consisting of:
 - 2 snap wrap spiders w/o ring
 - 2 collars with screws
 - 1 spacer



RRS Type Hub - Inch Bore and Keyway UPC Number Selection Table

Bore	Keyway	RRS090	RRS095	RRS099	RRS100	RRS110	RRS150	RRS190	RRS225
7/16	No Keyway	—	41229	52184	41231	—	—	—	—
1/2	No Keyway	41227	50357	41230	52199	—	—	—	—
1/2	1/8 x 1/16	56512	38145	—	38151	—	—	—	—
9/16	3/16 x 3/32	—	44474	—	—	—	—	—	—
5/8	No Keyway	—	—	—	—	38159	45265	—	—
5/8	3/16 x 3/32	38143	38146	38168	38152	—	50163	—	—
3/4	No Keyway	—	—	—	—	—	—	45273	45290
3/4	3/16 x 3/32	38144	38147	38169	38153	38160	45266	—	45292
7/8	1/4 x 1/8	—	—	—	52966	—	—	—	—
7/8	3/16 x 3/32	41228	38148	38170	38154	38161	45267	45274	45291
1	1/4 x 1/8	51672	38149	38171	38155	38162	45268	45275	45294
1-1/8	1/4 x 1/8	—	38150	38172	38156	38163	45153	45276	45295
1-1/8	5/16 x 5/32	—	—	—	—	—	48104	—	—
1-1/4	1/4 x 1/8	—	—	—	38157	38164	45392	48503	50743
1-3/8	5/16 x 5/32	—	—	—	38158	38165	44002	44725	45296
1-7/16	3/8 x 3/16	—	—	—	—	51579	49659	48933	49658
1-1/2	3/8 x 3/16	—	—	—	—	40816	49638	46628	45297
1-5/8	3/8 x 3/16	—	—	—	—	38166	41880	45277	45298
1-3/4	3/8 x 3/16	—	—	—	—	—	45162	45278	45299
1-7/8	1/2 x 1/4	—	—	—	—	—	44214	45279	41953
2	1/2 x 1/4	—	—	—	—	—	—	45280	45300
2-1/8	1/2 x 1/4	—	—	—	—	—	—	—	44724
2-3/8	5/8 x 5/16	—	—	—	—	—	—	—	45106

- Notes: ■ RRS inch hubs are standard with two set screws, including those with no keyway.
 ■ When referencing the Lovejoy UPC number in this table, include 685144 as a prefix to the number shown.

RRS / RRSC Type Hub - Metric Bore and Keyway UPC Number Selection Table

Bore	Keyway	RRSC150	RRSC190	RRSC225
32	No Keyway	55675	55679	55683
38	10 x 3.3	55676	55680	—
40	12 x 3.3	55677	55681	—
42	12 x 3.3	55678	55682	—

- Notes: ■ RRS inch hubs are standard with two set screws and are drilled to accept retaining collar. Collars are supplied with spacers.
 ■ When referencing the Lovejoy UPC number in this table, include 685144 as a prefix to the number shown.

RRS / RRSC Type Hub - Inch Bore and Keyway UPC Number Selection Table

Bore	Keyway	RRSC150	RRSC190	RRSC225
5/8	No Keyway	45269	—	—
3/4	No Keyway	—	45281	45301
3/4	3/16 x 3/32	45312	—	45303
7/8	3/16 x 3/32	45270	45282	45293
1	1/4 x 1/8	45271	45283	45305
1-1/8	1/4 x 1/8	44779	45284	45105
1-3/8	5/16 x 5/32	44006	45285	45306
1-1/2	3/8 x 3/16	46939	—	45307
1-5/8	3/8 x 3/16	14881	45286	45308
1-3/4	3/8 x 3/16	—	45287	45309
1-7/8	1/2 x 1/4	45272	45288	41954
2	1/2 x 1/4	—	45289	45310
2-1/8	1/2 x 1/4	—	—	45311

- Notes: ■ RRS inch hubs are standard with two set screws and are drilled to accept retaining collar. Collars are supplied with spacers.
 ■ When referencing the Lovejoy UPC number in this table, include 685144 as a prefix to the number shown.

RRS Type Spacer / Metric Bore / Keyway Item Selection

RRS Type Radially Removable Spacer Couplings

RRS Type couplings range from sizes RRS090 to RRS225.
The RRS Type coupling consists of:

RRS090 – RRS110:

- 2 Standard RRS Hubs
- 1 Spacer Assembly consisting of:
 - 2 snap wrap spiders w/o ring
 - 2 collars with screws
 - 1 spacer

RRS150 – RRS225:

- 1 Standard RRS Hub
- 1 Standard RRSC Hub – Drilled for collar
- 1 Spacer Assembly consisting of:
 - 2 snap wrap spiders w/o ring
 - 2 collars with screws
 - 1 spacer



Note: ■ RRS Type Inch Hubs provided standard with two set screws at 90°.

Features

- Standard API based spacers available
- Radially removable inserts
- Standard Lovejoy hub design with additional set screw at 90°

RRS Type Spacer UPC Number Selection Table

Description		RRS090	RRS095	RRS099	RRS100	RRS110	RRS150	RRS190	RRS225
3-1/2 in	Spacer Assembly	12620	12620	12630	12630	12644	12660	12676	12685
5 in	Spacer Assembly	26119	26119	26123	26123	26128	26770	27046	27041
7 in	Spacer Assembly	26120	26120	26124	26124	26129	27044	27043	27039
100mm	Spacer Assembly	55563	55563	55567	55567	55570	61056	61057	61058
140mm	Spacer Assembly	55281	55281	55569	55569	55571	55572	55573	55574
180mm	Spacer Assembly	61055	61055	55575	55575	55576	55577	55578	55579

Notes: ■ Spacer length denotes separation between shaft ends. Assembly includes spacer, two snap wrap spiders w/o ring, and two collars with screws. See page JW-11 for ordering information on spiders.
■ When referencing the Lovejoy UPC number in this table, include 685144 as a prefix to the number shown.

RRS Type Hub - Metric Bore and Keyway UPC Number Selection Table

Bore	Keyway	RRS090	RRS095	RRS099	RRS100	RRS110	RRS150	RRS190	RRS225
12	No Keyway	48276	—	—	—	—	—	—	—
14	No Keyway	41461	41465	—	—	—	—	—	—
14	5 x 2.3	51231	41466	60094	45101	—	—	—	—
15	No Keyway	—	46561	52697	41469	—	—	—	—
15	5 x 2.3	52096	45778	46972	47123	—	—	—	—
16	5 x 2.3	49198	41325	52098	55534	52092	52471	—	—
19	No Keyway	10777	—	—	—	41471	—	—	—
19	6 x 2.8	41462	41326	44157	41329	49700	48821	46717	—
20	6 x 2.8	41925	41467	47122	52093	41804	—	61497	—
23	8 x 3.3	50135	—	—	—	—	—	—	—
24	8 x 3.3	41463	41327	41990	41330	48301	48182	59109	—
25	8 x 3.3	41464	41468	45055	41470	41906	46751	52153	—
28	8 x 3.3	—	41328	50103	41331	41333	45679	52976	—
30	8 x 3.3	—	—	47132	48317	45681	41738	44471	48982
32	No Keyway	—	—	—	—	—	41472	41473	48319
32	10 x 3.3	—	—	—	41332	41334	41873	45562	41849
35	10 x 3.3	—	—	—	49925	45682	46562	58035	52197
38	10 x 3.3	—	—	—	—	41335	41337	41474	49664
40	12 x 3.3	—	—	—	—	45683	48318	48320	49605
42	12 x 3.3	—	—	—	—	41336	41338	41475	47492

Note: ■ When referencing the Lovejoy UPC number in this table, include 685144 as a prefix to the number shown.

C Type Cushions / Collar and Inch / Metric Bore / Keyway Item Selection

JW

C Type Couplings

The C Type coupling consists of two standard hubs, one cushion set and collar with hardware.

Features

- Greater torque and bore capacity than the L-Line series jaw coupling
- Elastomeric cushions are radially removable
- Cushions available in SXB rubber and Hytrel



C Type Cushions / Collar UPC Number Selection Table

Size	C226	C276	C280	C285	C295	C2955
Number of Cushions	6	6	6	6	6	10
SXB (NBR) cushion set	14547	14633	14712	14771	14805	14856
Hytrel[®] cushion set	27529	14637	14716	14774	14808	14859
Bronze cushion set	14545	—	—	—	51914	51915
Collar with hardware	40122	40123	40124	40292	40293	40293

- Notes:
- Chemical resistance and compatibility for cushions is described in Engineering Data section (page ED-9).
 - When referencing the Lovejoy UPC number in this table, include 685144 as a prefix to the number shown.

C Type Hub - Inch Bore and Keyway UPC Number Selection Table

Bore	Keyway	C226	C276	C280	C285	C295	C2955
7/8 RSB	No Keyway	40125	40126	—	—	—	—
1-1/8	1/4 x 1/8	26036	26050	—	—	—	—
1-1/4 RSB	No Keyway	—	—	20607	41036	—	—
1-1/4	1/4 x 1/8	26037	26051	48988	47173	—	—
1-3/8	5/16 x 5/32	26038	26052	46278	55546	—	—
1-7/16	3/8 x 3/16	26039	—	—	—	—	—
1-1/2 RSB	No Keyway	—	—	—	—	41037	—
1-1/2	3/8 x 3/16	26040	26053	46277	48366	44824	—
1-5/8	3/8 x 3/16	26041	26054	46194	41892	56078	—
1-3/4 RSB	No Keyway	—	—	—	—	—	41038
1-3/4	3/8 x 3/16	26042	26055	44011	52311	45780	—
1-7/8	1/2 x 1/4	26043	26056	44012	51533	47080	49075
2	1/2 x 1/4	26044	26057	48194	—	—	—
2-1/8	1/2 x 1/4	26045	26058	44370	49809	44711	—
2-1/4	1/2 x 1/4	26046	44547	—	—	—	—
2-3/8	5/8 x 5/16	26047	26060	44014	47288	44825	52703
2-1/2	5/8 x 5/16	26048	46120	51998	56779	45249	48454
2-5/8	5/8 x 5/16	—	46755	44013	—	50145	54549
2-7/8	3/4 x 3/8	—	26064	51525	49456	52702	48108
3	3/4 x 3/8	—	—	48193	—	—	—
3-3/8	7/8 x 7/16	—	—	—	47171	45402	49077
3-1/2	7/8 x 7/16	—	—	—	46844	52988	44545
3-5/8	7/8 x 7/16	—	—	—	—	—	50106
3-3/4	7/8 x 7/16	—	—	—	—	—	58378
3-7/8	1 x 1/2	—	—	—	48247	—	49351
4	1 x 1/2	—	—	—	—	—	55016

- Notes:
- RSB (Rough Stock Bore) hub has no keyway or set screw hole, it is not useable as shown and must be machined to proper bore tolerances. Hub includes inside sleeve and is drilled and tapped for collar bolts. Non-standard bores available – consult Lovejoy Engineering.
 - When referencing the Lovejoy UPC number in this table, include 685144 as a prefix to the number shown.

C Type Hub - Metric Bore and Keyway UPC Number Selection Table

Bore	Keyway	C226	C276	C280	C285	C295	C2955
30	8 x 3.3	62792	—	—	—	—	—
35	10 x 3.3	60243	47386	—	—	—	—
38	10 x 3.3	45348	62160	—	—	—	—
40	12 x 3.3	49379	54037	—	—	—	—
42	12 x 3.3	—	45219	—	—	—	—
45	14 x 3.8	52550	44723	58265	—	—	—
48	14 x 3.8	54288	—	52205	—	—	—
55	16 x 4.3	58011	58444	49012	—	—	—
60	18 x 4.4	—	47265	49378	—	—	—
65	18 x 4.4	—	52008	—	—	—	58676
70	20 x 4.9	—	59032	—	56794	54355	58677
75	20 x 4.9	—	—	—	—	47813	58678
80	22 x 5.4	—	—	—	44487	58675	58679
90	25 x 5.4	—	—	—	54363	—	—
95	25 x 5.4	—	—	—	—	—	62695

- Notes:
- RSB (Rough Stock Bore) hub has no keyway or set screw hole, it is not useable as shown and must be machined to proper bore tolerances. Hub includes inside sleeve and is drilled and tapped for collar bolts. Non-standard bores available – consult Lovejoy Engineering. For RSB hub part numbers see the C Type Inch Hub table.
 - When referencing the Lovejoy UPC number in this table, include 685144 as a prefix to the number shown.

H Type Cushions / Collar / Rough Stock Inch Bore / Keyway Item Selection

H Type Couplings

The H Type coupling consists of two hubs, two inside sleeves, one cushion set and one collar with hardware. H Type coupling hubs are supplied with an inside sleeve. For technical assistance, please contact Lovejoy Engineering.

Features

- Greater torque and bore capacity than the C-Line series jaw coupling
- Elastomeric cushions are radially removable
- Cushions available in SXB rubber and Hytrel



H Type Cushions / Collar UPC Number Selection Table

Size	H3067	H3567	H3667	H4067	H4567
Number of Cushions	14	14	14	14	14
SXB cushion set	15365	15386	15419	15457	15473
Hytrel® cushion set	15367	15388	45223	15459	55475
Collar with hardware	15361	15381	15411	55472	55476

Note: ■ When referencing the Lovejoy UPC number in this table, include 685144 as a prefix to the number shown.

H Type Hubs - Rough Stock Inch Bore UPC Number Selection Table

Bore	H3067	H3567	H3667	H4067	H4567
2-1/8 RSB	48070	—	—	—	—
2-5/8 RSB	—	50883	—	—	—
3 RSB	—	—	47878	—	—
3-1/4 RSB	—	—	—	55473	—
3-1/2 RSB	—	—	—	—	55477

Notes: ■ RSB (Rough Stock Bore) hub has no keyway or set screw hole.
 ■ RSB bores should not be used as shown and may need additional machining to reach proper tolerances.
 ■ When referencing the Lovejoy UPC number in this table, include 685144 as a prefix to the number shown.

RRC Type Spacer / Adapter Hubs

Item Selection

JW RRC Type Radially Removable Spacer Coupling

RRC Type couplings range from sizes RRC226 to RRC2955. The RRC Type coupling consists of:

- 2 RRC Hub Adapters (includes bolts)
- 1 Spacer assembly consisting of:
 - 2 RRC Jaw rings
 - 1 collar with hardware
 - 1 set of SXB (NBR) cushions

RRC Type Spacer UPC Number Selection Table

Description		RRC226	RRC276	RRC280	RRC285	RRC295	RRC2955
3-1/2 in	Spacer Assembly	55709	55712	55715	55718	—	—
4 in	Spacer Assembly	—	—	—	—	55721	55724
5 in	Spacer Assembly	55710	55713	55716	55719	55722	55751
7 in	Spacer Assembly	55711	55174	55717	55720	55723	55752

Note: ■ When referencing the Lovejoy UPC number in this table, include 685144 as a prefix to the number shown.

RRC Type Adapter Hubs - Rough Stock Inch Bore UPC Number Selection Table

Bore	RRC226	RRC276	RRC280	RRC285	RRC295	RRC2955
7/8 RSB	55770	55771	—	—	—	—
1-1/4 RSB	—	—	52030	55772	—	—
1-1/2 RSB	—	—	—	—	55773	—
1-3/4 RSB	—	—	—	—	—	55774

Note: ■ When referencing the Lovejoy UPC number in this table, include 685144 as a prefix to the number shown.

L, AL, LC, C, H and RRS Type Ratings Performance Data

Jaw Type Performance Ratings

Size	Elastomeric Member	Number of Jaws	Basic HP Ratings @ Varying RPM				Torque Rating		Max Bore		Max x1000
			100	1200	1800	3600	in-lbs	Nm	in	mm	RPM
L, AL & LC Type											
L035	SOX (NBR)	2	0.006	0.07	0.10	0.22	3.5	0.40	0.375	9	31.0
L050/AL050	SOX (NBR)	2	0.042	0.50	0.75	1.51	26.3	2.97	0.625	16	18.0
L050/AL050	Hytrel*	2	0.080	0.96	1.43	2.88	50.0	5.65	0.625	16	18.0
L070/AL070	SOX (NBR)	2	0.070	0.84	1.23	2.52	43.2	4.88	0.750	19	14.0
L070/AL070	Hytrel	2	0.180	2.16	3.26	6.48	114.0	12.88	0.750	19	3.6
L075/AL075	SOX (NBR)	3	0.140	1.68	2.57	5.04	90.0	10.17	0.875	22	11.0
L075/AL075	Hytrel	3	0.360	4.32	6.48	12.96	227.0	25.65	0.875	22	3.6
L090/AL090/LC090	SOX (NBR)	3	0.230	2.76	4.11	8.28	144.0	16.27	1.000	25	9.0
L090/AL090	Hytrel	3	0.640	7.68	11.50	23.04	401.0	42.31	1.000	25	3.6
L095/AL095/LC095	SOX (NBR)	3	0.310	3.72	5.50	11.16	194.0	21.92	1.125	32	9.0
L095/AL095	Hytrel	3	0.890	10.68	16.00	32.04	561.0	63.38	1.125	32	3.6
L099/AL099/LC099	SOX (NBR)	3	0.500	6.00	9.10	18.00	318.0	35.93	1.180	30	7.0
L099/AL099	Hytrel	3	1.260	15.12	22.60	45.36	792.0	89.48	1.180	30	3.6
L100/AL100/LC100	SOX (NBR)	3	0.660	7.92	11.90	23.76	417.0	47.11	1.380	35	7.0
L100/AL100	Hytrel	3	1.800	21.60	32.40	64.80	1,134.0	128.12	1.380	35	3.6
L110/AL110/LC110	SOX (NBR)	3	1.260	15.12	23.00	45.36	792.0	89.48	1.620	42	5.0
L110/AL110	Hytrel	3	3.600	43.20	65.00	129.60	2,268.0	256.25	1.620	42	5.0
L150/LC150	SOX (NBR)	3	2.000	24.00	35.00	72.00	1,240.0	140.10	1.880	48	5.0
L150	Hytrel	3	5.900	70.80	106.00	212.40	3,708.0	418.95	1.880	48	5.0
AL-150	SOX (NBR)	4	2.300	27.60	41.40	82.80	1,450.0	163.83	1.880	48	5.0
L190/LC190	SOX (NBR)	3	2.700	32.40	49.00	97.20	1,728.0	195.24	2.120	55	5.0
L190	Hytrel	3	7.400	88.80	134.00	266.40	4,680.0	528.77	2.120	55	5.0
L225/LC225	SOX (NBR)	3	3.700	44.40	67.00	133.20	2,340.0	264.38	2.620	65	4.2
L225	Hytrel	3	9.900	118.80	178.00	356.40	6,228.0	703.67	2.620	65	4.2
L276	SOX (NBR)	3	7.500	90.00	135.00	+	4,716.0	532.84	2.880	73	1.8
C Type											
C226	SXB (NBR)	3	4.700	56.40	85.00	169.20	2,988.0	337.60	2.500	64	4.8
C226	Hytrel	3	9.400	112.80	170.00	338.40	5,940.0	671.13	2.500	64	4.8
C276	SXB (NBR)	3	7.500	90.00	135.00	270.00	4,716.0	532.84	2.880	73	4.2
C276	Hytrel	3	15.000	180.00	269.00	540.00	9,432.0	1065.67	2.880	73	4.2
C280	SXB (NBR)	3	12.000	114.00	216.00	+	7,560.0	854.17	3.000	76	3.5
C280	Hytrel	3	22.000	264.00	396.00	+	13,866.0	1,566.65	3.000	76	3.5
C285	SXB (NBR)	3	14.600	175.20	262.00	+	9,182.0	1,037.43	4.000	102	3.2
C285	Hytrel	3	26.000	312.00	476.00	+	16,680.0	1,882.33	4.000	102	3.2
C295	SXB (NBR)	3	18.000	216.00	324.00	+	11,340.0	1,281.25	3.500	89	2.3
C295	Hytrel	3	36.000	432.00	648.00	+	22,680.0	2,562.50	3.500	89	2.3
C2955	SXB (NBR)	5	30.000	360.00	540.00	+	18,900.0	2,135.42	4.000	102	2.3
C2955	Hytrel	5	60.000	720.00	1,080.00	+	37,800.0	4,270.83	4.000	102	2.3
H Type											
H3067	SXB (NBR)	7	53.000	639.00	954.00	+	33,396.0	3,773.25	4.500	114	2.3
H3067	Hytrel	7	75.000	900.00	1,348.00	+	47,196.0	5,332.44	4.000	102	2.3
H3567	SXB (NBR)	7	74.000	888.00	1,332.00	+	46,632.0	5,268.72	5.000	127	2.1
H3567	Hytrel	7	100.000	1,200.00	1,799.00	+	63,000.0	7,118.06	4.500	114	2.1
H3667	SXB (NBR)	7	103.000	1,236.00	1,851.00	+	64,812.0	7,322.78	5.620	146	1.9
H3667	Hytrel	7	140.000	1,680.00	2,519.00	+	88,200.0	9,965.28	5.000	127	1.9
H4067	SXB (NBR)	7	140.000	1,680.00	2,520.00	+	88,224.0	9,967.99	6.250	159	1.8
H4067	Hytrel	7	200.000	2,400.00	3,600.00	+	126,000.0	14,236.11	5.500	140	1.8
H4567	SXB (NBR)	7	190.000	2,280.00	+	+	119,700.0	13,524.30	7.000	178	1.5
H4567	Hytrel	7	270.000	3,240.00	+	+	170,000.0	19,207.45	6.000	152	1.5
RRS Type											
RRS090	SOX (NBR)	3	0.230	2.76	4.11	8.28	144.0	16.27	1.000	25	3.6
RRS095	SOX (NBR)	3	0.310	3.72	5.50	11.16	194.0	21.92	1.120	28	3.6
RRS099	SOX (NBR)	3	0.500	6.00	9.10	18.00	318.0	35.93	1.180	30	3.6
RRS100	SOX (NBR)	3	0.660	7.92	11.90	23.76	417.0	47.11	1.380	35	3.6
RRS110	SOX (NBR)	3	1.260	15.12	23.00	45.36	792.0	89.48	1.620	42	3.6
RRS150	SOX (NBR)	3	2.000	24.00	35.00	72.00	1,240.0	140.10	1.880	48	3.6
RRS190	SOX (NBR)	3	2.700	32.40	49.00	97.20	1,728.0	195.24	2.120	55	3.6

Notes: ■ + indicates: exceeds RPM capacity.
 ■ See Chart on page JW-10 for Bronze and Urethane ratings.

Elastomers In Compression (Spiders)

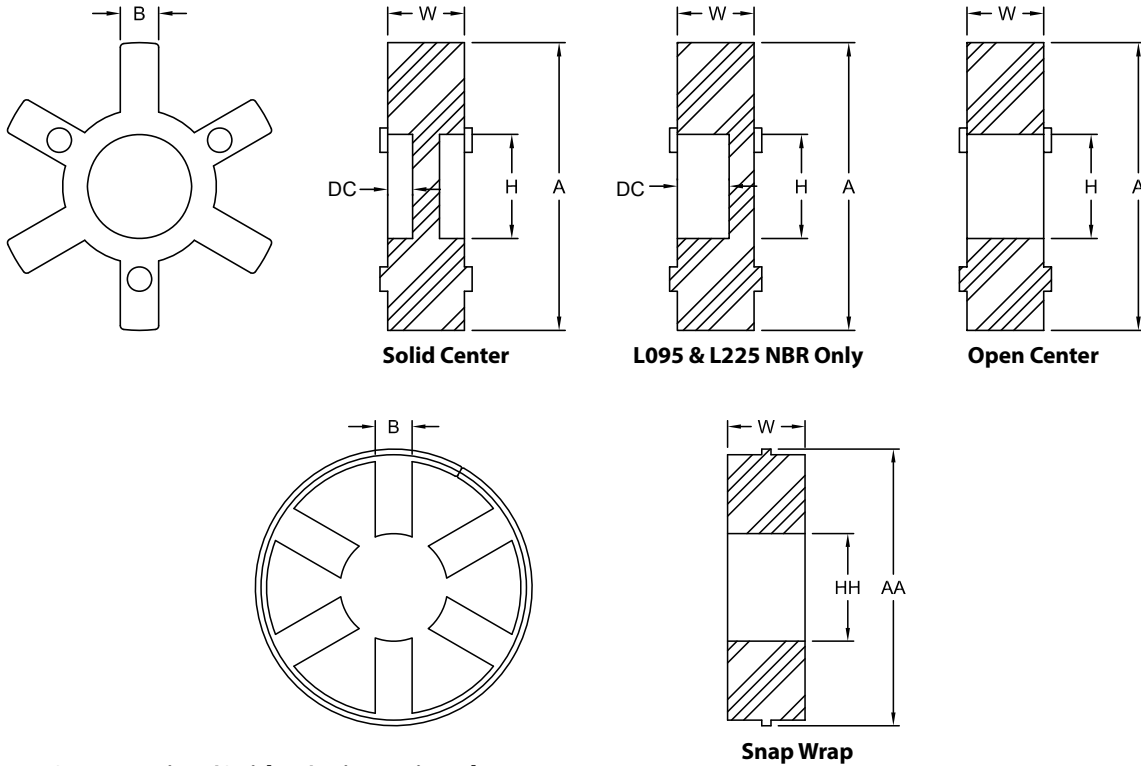

Elastomers In Compression (Spiders) Dimensional Data

Size					A	DC	H					A	H				AA			HH	W	B
					Solid Center Spiders			Open Center Spiders							Snap Wrap Spiders			All				
	Material Available				in	in	in	Material Available				in	in	in	in	in	Material	in	in	in	in	
	NBR	Urethane	Hytrel	Bronze				NBR	Urethane	Hytrel	Bronze											
SOX	URE	HYT	BRZ	SOX	URE	HYT	BRZ	NBR	URE	HYT	BRZ	NBR	URE	HYT	BRZ	in	in	in	in			
L035	X	—	—	—	0.62	—	—	—	—	—	—	—	—	—	—	N/A	—	—	0.28	0.21		
L050	X	X	X	—	1.07	—	—	—	—	—	X	1.07	0.31	0.31	N/A	—	—	0.42	0.27			
L070	X	X	—	—	1.38	—	—	X	X	X	X	1.38	0.50	0.50	N/A	—	—	0.42	0.27			
L075	X	—	—	—	1.75	—	—	X	X	X	X	1.75	0.75	0.75	N/A	—	—	0.44	0.27			
L090/L095	X	—	—	—	2.12	0.18	0.88	X	X	X	X	2.12	0.88	0.75	X	2.56	1.06	0.44	0.36			
L099/L100	X	—	—	—	2.54	0.25	1.03	X	X	X	X	2.54	1.03	1.03	X	3.08	1.37	0.61	0.43			
L110	X	—	X	—	3.31	NBR .25	1.19	X	X	X	X	3.31	1.18	1.38	X	3.87	1.50	0.75	0.45			
						HYT .18																
L150	X	—	X	—	3.75	NBR .31	1.25	X	X	X	X	3.75	1.25	1.125	X	4.56	1.75	0.88	0.59			
						HYT .21																
L190	X	—	X	—	4.50	NBR .31	1.38	X	X	X	X	4.50	1.38	1.38	X	5.18	2.25	0.88	0.60			
						HYT .18																
L225	X	—	X	—	4.98	NBR .38	1.75	X	X	X	X	4.98	1.75	1.75	URE	5.44	2.75	0.88	0.73			
						HYT .18																
L276	—	—	—	—	—	—	—	X	—	—	X	6.19	1.75	1.75	N/A	—	—	1.45	0.75			

Notes: ■ X indicates: Applicable.
 ■ See pages JW-5 and JW-10 for more information on spiders.

L, C and H Type Dimensional Data

L, C and H Type Couplings

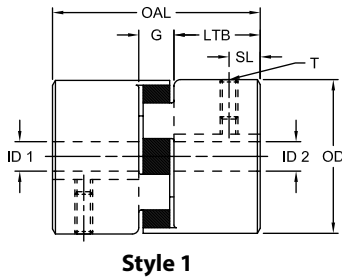

Style 1

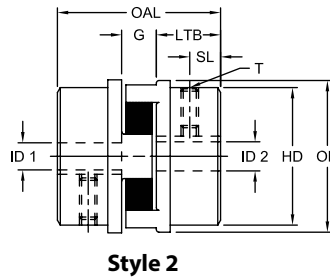

Style 2

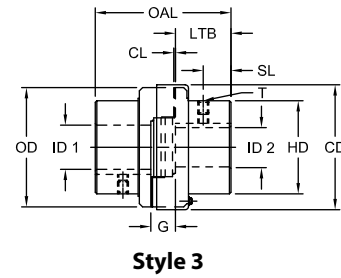

Style 3

L Type, C Type & H Type Dimensional Data

Size	Style No	OAL in	G in	LTB in	SL in	CL in	T in	ID1 - ID2		OD in	CD in	HD in	Weight		Moment of Inertia (Solid) WR ² lb-in ²		
								Min Bore in mm	Max Bore in mm				Min Bore lbs	Max Bore lbs			
L Type																	
L035	1	0.81	0.28	0.27	0.13	N/A	#6-32	0.125	3	0.375	9	0.63	N/A	0.63	0.10	0.10	0.003
L050	1	1.71	0.48	0.62	0.31	N/A	1/4-20	0.250	6	0.625*	16	1.08	N/A	1.08	0.30	0.20	0.054
L070	1	1.98	0.48	0.75	0.38	N/A	1/4-20	0.250	6	0.750	19	1.36	N/A	1.36	0.60	0.40	0.115
L075	1	2.13	0.50	0.82	0.31	N/A	1/4-20	0.250	6	0.875	22	1.75	N/A	1.75	1.00	0.80	0.388
L090	1	2.15	0.52	0.82	0.44	N/A	1/4-20	0.250	6	1.000	25	2.11	N/A	2.11	1.50	1.20	0.772
L095	1	2.51	0.52	1.00	0.44	N/A	5/16-18	0.438	12	1.125	29	2.11	N/A	2.11	1.80	1.30	0.890
L099	1	2.84	0.71	1.06	0.44	N/A	5/16-18	0.438	12	1.188	30	2.54	N/A	2.54	2.50	2.00	2.048
L100	1	3.48	0.71	1.38	0.44	N/A	5/16-18	0.438	12	1.375	35	2.54	N/A	2.54	3.20	2.40	2.783
L110	1	4.22	0.88	1.68	0.75	N/A	3/8-16	0.625	16	1.625	42	3.32	N/A	3.32	6.60	5.30	8.993
L150	1	4.50	1.00	1.75	0.75	N/A	3/8-16	0.625	16	1.875	48	3.75	N/A	3.75	8.80	7.00	11.477
L190	2	4.86	1.00	1.94	0.88	N/A	1/2-13	0.750	19	2.125	55	4.50	N/A	4.00	15.30	12.30	39.256
L225	2	5.34	1.00	2.18	1.00	N/A	1/2-13	0.750	19	2.625	67	5.00	N/A	4.25	19.60	15.00	65.000
L276	2	7.82	1.58	3.12	1.56	N/A	1/2-13	0.875	22	2.875	73	6.18	N/A	5.00	40.00	30.50	188.000
C Type																	
C226	3	7.00	1.50	2.75	1.38	0.12	1/2-13	0.875	22	2.500	64	5.15	5.50	4.12	29.00	22.00	74.000
C276	3	7.87	1.63	3.12	1.56	0.12	1/2-13	0.875	22	2.875	73	6.18	6.53	5.00	47.00	36.00	188.000
C280	3	7.87	1.63	3.12	1.56	0.12	1/2-13	1.250	32	3.000	76	7.50	7.81	5.50	61.00	49.00	362.000
C285	3	9.13	1.63	3.75	1.75	0.12	5/8-11	1.250	32	4.000	102	8.50	8.88	6.50	87.00	68.00	642.000
C295	3	9.38	1.88	3.75	1.88	0.12	5/8-11	1.500	38	3.500	89	9.12	9.62	6.25	97.00	78.00	862.000
C2955	3	10.38	1.88	4.25	2.12	0.12	5/8-11	1.750	44	4.000	102	9.12	9.62	7.12	117.00	90.00	932.000
H Type																	
H3067																	
SXB(NBR)	3	11.62	2.12	4.75	2.37	0.12	5/8-11	2.125	54	4.500	114	10.00	10.68	7.00	162.00	123.00	1,485.000
HYTREL		11.62	2.12	4.75	2.37	0.12	5/8-11	2.125	54	4.000	102	10.00	10.68	7.00	162.00	123.00	1,485.000
H3567																	
SXB(NBR)	3	12.38	2.38	5.00	2.50	0.12	5/8-11	2.625	67	5.000	127	11.00	11.68	7.75	246.00	195.00	2,174.000
HYTREL		12.38	2.38	5.00	2.50	0.12	5/8-11	2.625	67	4.500	114	11.00	11.68	7.75	246.00	195.00	2,174.000
H3667																	
SXB(NBR)	3	13.88	2.62	5.63	2.81	0.12	3/4-10	3.000	76	5.625	143	12.00	12.45	8.75	262.00	190.00	3,591.000
HYTREL		13.88	2.62	5.63	2.81	0.12	3/4-10	3.000	76	5.000	127	12.00	12.45	8.75	262.00	190.00	3,591.000
H4067																	
SXB(NBR)	3	15.38	2.88	6.25	3.12	0.12	3/4-10	3.250	83	6.250	159	13.25	14.00	9.75	390.00	291.00	6,287.000
HYTREL		15.38	2.88	6.25	3.12	0.12	3/4-10	3.250	83	5.500	140	13.25	14.00	9.75	390.00	291.00	6,287.000
H4567																	
SXB(NBR)	3	17.12	3.12	7.00	3.50	0.12	3/4-10	3.500	89	7.000	178	14.50	15.75	10.75	575.00	435.00	10,565.000
HYTREL		17.12	3.12	7.00	3.50	0.12	3/4-10	3.500	89	6.000	152	14.50	15.75	10.75	575.00	435.00	10,565.000

- Notes:
- * indicates: Without keyway.
 - 2 indicates: Maximum bore is less for H Type couplings with Hytrel due to increased torque capacity.
 - N/A indicates: Not Applicable.
 - Jaw coupling hubs are standard with one set screw, for two set screws see RRS & RRC sections.
 - See pages JW-10 and JW-23 for Performance Data.

LC and AL Type Dimensional Data

JW

LC and AL Type Couplings

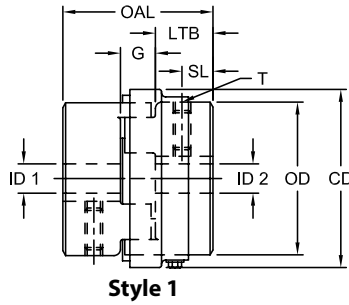

Style 1

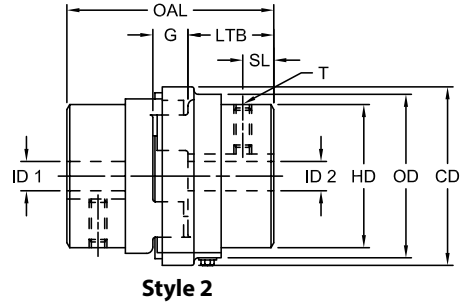

Style 2

LC Type Dimensional Data

Size	Style No	OAL in	G in	LTB in	SL in	T in	ID1 - ID2				CD in	OD in	HD in	Weight		Moment of Inertia (Solid) WR ² lb-in ²
							Min Bore		Max Bore					Solid lbs	Max Bore lbs	
LC090	1	2.12	0.50	0.81	0.44	1/4-20	0.250	6	1.00	25	2.54	2.11	2.11	1.5	1.2	0.772
LC095	1	2.50	0.50	1.00	0.44	5/16-18	0.437	11	1.12	29	2.54	2.11	2.11	1.8	1.3	0.890
LC099	1	2.87	0.75	1.06	0.44	5/16-18	0.437	11	1.18	30	3.11	2.53	2.53	2.5	2.0	2.048
LC100	1	3.50	0.75	1.38	0.44	5/16-18	0.437	11	1.37	35	3.11	2.53	2.53	3.5	2.5	2.783
LC110	1	4.25	0.87	1.69	0.75	3/8-16	0.625	16	1.62	41	3.81	3.31	3.31	6.6	5.0	8.993
LC150	1	4.50	1.00	1.75	0.75	3/8-16	0.625	16	1.88	48	4.41	3.75	3.75	9.1	7.0	11.477
LC190	2	4.88	1.00	1.94	0.88	1/2-13	0.750	19	2.12	54	5.01	4.50	4.00	17.0	13.0	39.256
LC225	2	5.38	1.00	2.19	1.00	1/2-13	0.875	22	2.62	67	5.61	5.00	4.25	23.0	18.0	62.003

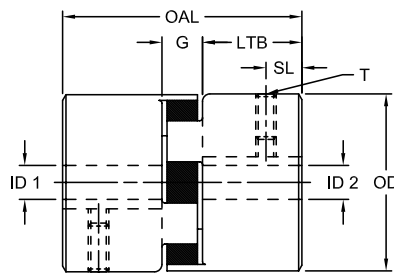

Style 1

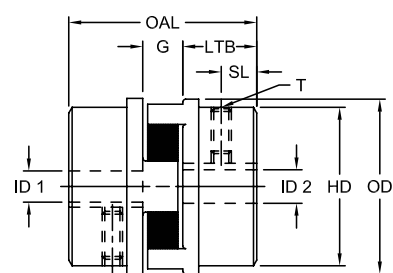

Style 2

AL Type Dimensional Data

Size	Style No	OAL in	G in	LTB in	SL in	T in	ID1 - ID2				CD in	OD in	HD in	Weight		Moment of Inertia (Solid) WR ² lb-in ²
							Min Bore		Max Bore					Solid lbs	Max Bore lbs	
AL050	1	1.71	0.48	0.62	0.31	1/4-20	0.250	6	0.625	16	N/A	1.08	1.08	0.2	0.2	0.020
AL070	1	2.00	0.50	0.75	0.38	1/4-20	0.250	6	0.750	19	N/A	1.36	1.36	0.3	0.2	0.040
AL075	2	2.12	0.50	0.81	0.31	1/4-20	0.250	6	0.875	22	N/A	1.75	1.53	0.4	0.3	0.121
AL090	2	2.34	0.52	0.91	0.34	1/4-20	0.250	13	0.875	22	N/A	2.12	1.53	0.5	0.4	0.271
AL095	1	2.50	0.50	1.00	0.44	5/16-18	0.500	13	1.125	29	N/A	2.12	2.12	0.8	0.6	0.336
AL099	2	2.81	0.75	1.03	0.44	5/16-18	0.500	13	1.187	30	N/A	2.53	2.06	1.0	0.8	0.644
AL100	1	3.50	0.75	1.37	0.44	5/16-18	0.500	13	1.375	35	N/A	2.53	2.53	1.5	1.1	1.207
AL110	1	4.25	0.87	1.69	0.75	5/16-18	0.625	16	1.625	41	N/A	3.31	3.31	2.7	2.1	3.531
AL150	2	4.50	1.00	1.75	0.63	5/16-18	0.625	16	1.875	48	N/A	4.25	3.19	3.7	2.8	7.002

Notes: ■ N/A indicates: Not Applicable.
■ See pages JW-10 and JW-23 for Performance Data.

RRS and RRC Type Dimensional Data

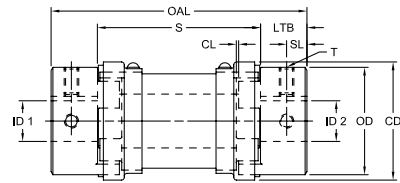

Style 1

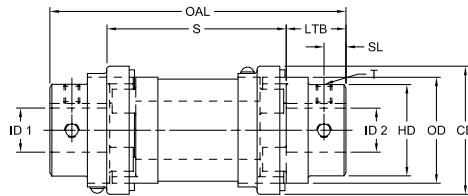

Style 2

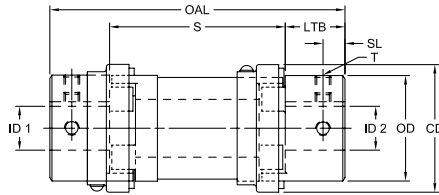

Style 3

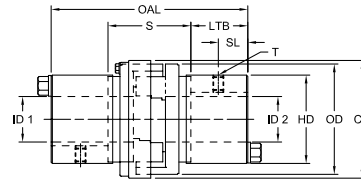

Style 4

RRS & RRC Type Dimensional Data

Size	Style No	OAL in	S in	LTB in	SL in	CL in	T in	ID1 - ID2				CD in	OD in	HD in	Weight lbs
								Min Bore		Max Bore					
								in	mm	in	mm				
RRS090	1	5.12	3.5	0.81	0.43	0.09	1/4-20	0.250	6	1.000	25	2.50	2.11	—	1.7
		6.62	5.0												1.8
		8.62	7.0												1.9
RRS095	1	5.50	3.5	1.00	0.43	0.09	5/16-18	0.437	11	1.125	29	2.50	2.11	—	1.9
		7.00	5.0												2.0
		9.00	7.0												2.1
RRS099	1	5.62	3.5	1.06	0.44	0.12	5/16-18	0.437	11	1.187	30	3.12	2.53	—	2.2
		7.12	5.0												2.5
		9.12	7.0												2.8
RRS100	1	6.25	3.5	1.38	0.44	0.12	5/16-18	0.437	11	1.375	35	3.12	2.53	—	3.2
		7.75	5.0												3.5
		9.75	7.0												3.8
RRS110	1	6.88	3.5	1.68	0.75	0.12	5/16-18	0.625	16	1.625	41	3.81	3.31	—	6.2
		8.36	5.0												6.6
		10.36	7.0												7.2
RRS150	2	7.00	3.5	1.75	0.62	0.12	3/8-16	0.625	16	1.875	48	4.44	3.75	—	12.2
		8.50	5.0												15.7
		10.50	7.0												20.3
RRS190	3	7.38	3.5	1.94	0.88	0.12	1/2-13	0.750	19	2.125	55	5.00	4.50	4.00	23.0
		8.88	5.0												28.2
		10.88	7.0												35.0
RRS225	3	7.88	3.5	2.18	1.00	0.12	1/2-13	0.750	19	2.625	67	5.62	5.00	4.25	26.5
		9.38	5.0												33.0
		11.38	7.0												41.4
RRC226	4	9.19	3.5	2.84	1.38	N/A	1/2-13	0.875	22	2.125	54	5.50	5.16	4.12	37.0
		10.68	5.0												43.0
		12.68	7.0												49.0
RRC276	4	8.60	3.5	2.47	1.00	N/A	1/2-13	0.875	22	2.875	73	6.50	6.18	5.00	52.0
		9.94	5.0												59.0
		11.94	7.0												69.0
RRC280	4	5.50	3.5	2.47	1.00	N/A	1/2-13	1.250	32	3.375	86	7.81	7.50	5.50	66.0
		9.94	5.0												75.0
		11.94	7.0												87.0
RRC285	4	9.31	3.5	2.87	1.00	N/A	1/2-13	1.250	32	4.125	105	8.88	8.50	6.50	92.0
		10.75	5.0												104.0
		12.75	7.0												121.0
RRC295	4	9.50	4.0	2.75	1.38	N/A	1/2-13	1.500	38	4.125	105	9.56	9.12	6.50	100.0
		10.50	5.0												112.0
		12.50	7.0												128.0
RRC2955	4	9.50	4.0	2.75	1.88	N/A	5/8-11	1.750	44	4.125	105	9.56	9.12	6.50	96.0
		10.50	5.0												111.0
		12.50	7.0												132.0

Notes: ■ N/A indicates: Not Applicable.
 ■ See pages JW-10 and JW-23 for Performance Data.

RRS Type Metric Spacer, L Type / Special Lengths
Dimensional Data

JW

RRS Type - Metric Spacer Dimensional Data

Size	Style No	ID1 - ID2				S mm	OAL mm	Spacer Weight	
		Min Bore		Max Bore				lbs	Kg
		in	mm	in	mm				
RRS090	1	0.250	11	1.000	25	100	141	0.83	0.38
						140	181	1.21	0.55
						180	221	1.59	0.79
RRS095	1	0.437	11	1.125	28	100	151	0.83	0.38
						140	191	1.21	0.55
						180	231	1.59	0.79
RRS099	1	0.437	11	1.188	30	100	154	1.08	0.49
						140	194	1.63	0.74
						180	234	2.17	0.98
RRS100	1	0.437	11	1.375	35	100	170	1.08	0.49
						140	210	1.63	0.74
						180	250	2.17	0.98
RRS110	1	0.625	16	1.625	41	100	186	1.64	0.74
						140	226	2.55	1.16
						180	266	3.48	1.58
RRS150	2	0.625	16	1.875	48	100	189	5.92	2.69
						140	229	9.54	4.33
						180	269	13.19	5.98
RRS190	2	0.750	19	2.125	54	100	199	8.75	3.97
						140	239	14.00	6.35
						180	277	19.26	8.74
RRS225	2	0.750	19	2.625	67	100	221	10.83	4.91
						140	261	17.49	7.93
						180	291	24.18	10.97

Note: ■ See pages JW-10 and JW-23 for Performance Data.

L Type Hubs - Special Lengths

Size	OAL	LTB	OAL	LTB
	Standard Dimensions		Special Dimensions	
	Complete Couplings Overall Length	Hub Length Thru Bore	Complete Couplings Overall Length	Hub Length Thru Bore
	in	in	in	in
L050	1.720	0.620	1.10	0.31
			1.34	0.43
			2.24	0.88
L070	2.000	0.750	1.23	0.38
			3.00	1.25
L095	2.500	1.000	3.86	1.68
L100	3.500	1.375	7.99	3.62
L110	4.250	1.690	2.37	0.75
			2.47	0.80
			6.63	2.88

Notes: ■ For ordering information on any special length jaw hub, please contact Lovejoy Customer Service.

■ The Overall Length is calculated using two hubs with the same length thru bore.

